

PRICE LIST

DPM01102022
(w.e.f. 01st October 2022)

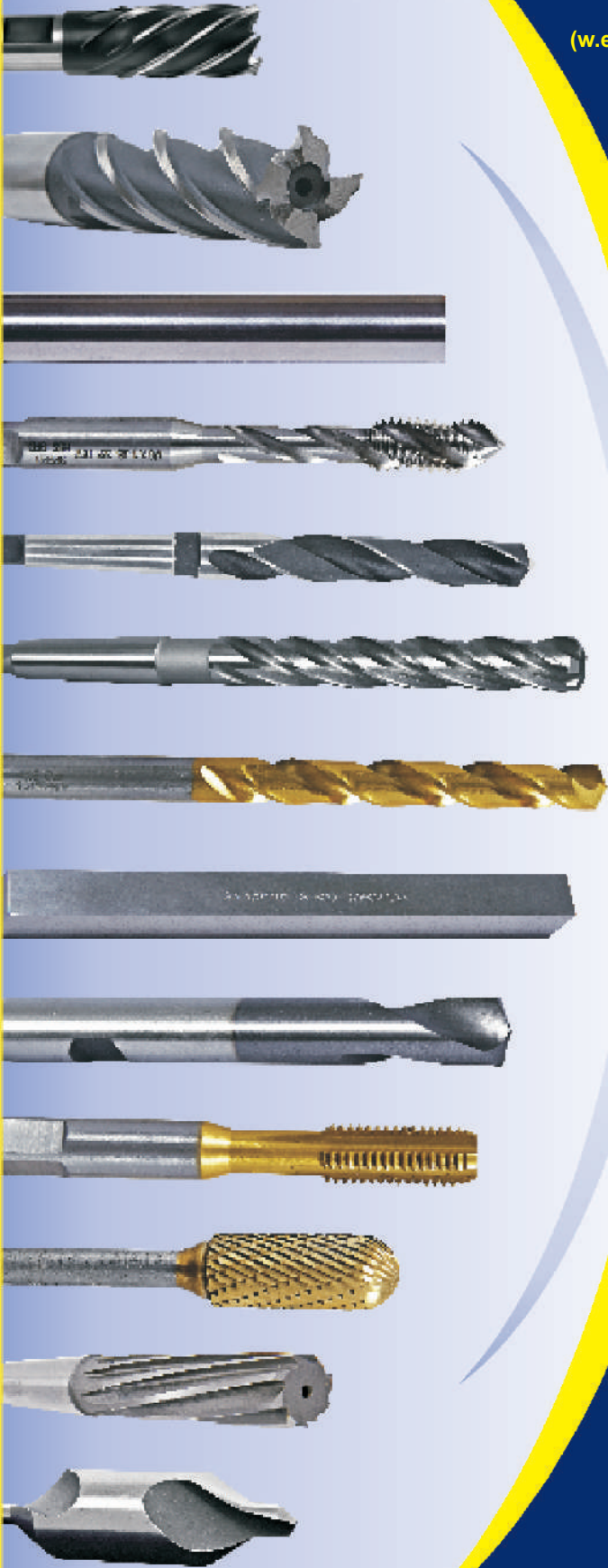

HSS Toolbits

HSS Drills

HSS Endmills

HSS Reamers

HSS Core Drills

HSS & TCT Annular Cutters

HSS Taps

Carbide Tipped Tools

Tungsten Carbide Rotary Burrs

Solid Carbide Drills

Solid Carbide End Mills



Terms & Conditions

1. All Govt. taxes and levies are extra.
2. Delivery F.O.R Destination
3. This price list is effective from 01.10.2022 and super ceeds our previous Price list, Prices are subject to revision without any notice.
4. For unlisted intermediate sizes, please contact the respective sales team.
5. We also manufacture special products as per your requirements.
6. All MTO items required in minimum order value of Rs.20,000/- net or MOQ as per size whichever is higher.
7. If coating (TiN, TiCN, TiAlN) required while ordering will be charged extra if not included in price list. Minimum Order Value should be Rs.20,000 in each size or minimum order qty. as mentioned.

Jobber, Stub &	:	All sizes upto Dia 13.00mm to be ordered
Long Series Drills	:	In multiple of 10 Nos.
Centre Drills	:	Upto 1/2" (12.50 mm) to be ordered in multiple of 100 Nos.
ToolBits	:	Upto 1/2" (12.50 mm) to be ordered in multiple of 10Nos.
Parallel Shank Endmills :		Upto 1/2" (12.50 mm) to be ordered in multiple of 10Nos

DESCRIPTION	PAGE NO.
HSS TOOLBIT BLANKS	1 - 4
HSS TOOLBIT BLANKS, HSS FLAT (RECTANGULAR) & PARTING TOOLBITS	
ZEDD ++	
HSS DRILLS	5 - 14
HSS PARALLEL SHANK JOBBER SERIES	
DRILL SET & HSS PARALLEL SHANK STUB SERIES, LONG & EXTRA LONG SERIES	
CENTRE DRILLS, HSS TAPER SHANK DRILLS, LONG & EXTRA LONG SERIES	
MASONRY DRILLS	
HSS ENDMILLS & REAMERS	15 - 17
HSS PARALLEL SHANK ENDMILLS, SLOT DRILLS, LONG SERIES	
ROUGHING ENDMILLS M42	
HSS REAMERS & TAPER PIN REAMERS (TAPER 1 IN 50) & (TAPER 1 IN 48)	
CORE DRILLS	18 - 18
HIGH SPEED STEEL TAPER SHANK CORE DRILLS	
HSS & TCT ANNULAR CUTTERS	19 - 20
HSS & TCT ANNULAR CUTTER	
HSS TAPS	21 - 29
HSS TAPS COARSE PITCH & FINE PITCH	
HSS HAND TAPS - BSW,BSF,UNC,UNF,BSCy, BA & PIPE TAPS	
HSS NIB TAPS & UN TAPS	
HSS GROUND THREAD HAND TAPS - COARSE PITCH - HELICOIL	
HIGH PERFORMANCE PLATINUM CUT (EDGE)	
TUNGSTEN CARBIDE TIPPED TOOLS	30 - 36
STRAIGHT ROUND & GROOVING TOOLS, STRAIGHT THREADING TOOLS, INTERNAL	
& EXTERNAL THREADING TOOLS, THREADING TOOLS WITH "V" PROFILE	
TUNGSTEN CARBIDE ROTARY BURRS	37 - 39
CONICAL,CYLINDRICAL RADIUS END, CYLINDRICAL FLAME,CONE,OVAL,RIM,BALL,	
TREE POINTED END,TREE RADIUS END, INVERTED CONE	
SOLID CARBIDE DRILLS & ENDMILLS	40 - 42
STRAIGHT SHANK SOLID CARBIDE DRILLS (JOBBER & STUB SERIES)	
2/4 FLUTE CENTRE CUTTING UNCOATED & TIALN COATED,BALL NOSE ENDMILLS,	
LONG /EXTRA LONG LENGTH 4 FLUTE CENTRE CUTTING TIALN COATED	
SUGGESTED SPEED AND FEED DATA DOR SOLID CARBIDE ENDMILLS & DRILLS	43

HSS TOOLBIT BLANKS



NOMINAL SIZE			GRADES						PKT. QTY.
MM	INCH	EQUIVALENT MM	ZEDD SQ. Price Each Rs.	S100 M35 SQ./RD Price Each Rs.	S200 M42 SQ./RD Price Each Rs.	S400 T42 SQ./RD Price Each Rs.	S400E M35 SQ./RD Price Each Rs.	S500 T42 SQ./RD Price Each Rs.	
-	3/32 x 2.1/2	2.38 x 63.50	140	310	436	459	365	488	10
-	3/32 x 3	2.38 x 76.20	164	501	701	735	588	781	10
3 x 75	1/8 x 3	3.18 x 76.20	164	343	483	510	401	531	10
3 x 100	1/8 x 4	3.18 x 101.60	215	618	889	933	734	970	10
4 x 75	5/32 x 3	3.97 x 76.20	164	347	495	520	410	532	10
4 x 100	5/32 x 4	3.97 x 101.60	220	538	769	808	640	829	10
5 x 75	3/16 x 3	4.76 x 76.20	140	274	360	377	321	390	10
5 x 100	3/16 x 4	4.76 x 101.60	185	404	525	552	477	578	10
5 x 150	3/16 x 6	4.76 x 152.40	286	730	1,120	1,183	856	1,184	10
6 x 75	1/4 x 3	6.35 x 76.20	160	347	483	510	410	532	10
6 x 100	1/4 x 4	6.35 x 101.60	188	472	641	676	552	703	10
6 x 150	1/4 x 6	6.35 x 152.40	271	772	1,048	1,105	909	1,147	10
6 x 200	1/4 x 8	6.35 x 203.20	386	1,281	1,774	1,867	1,502	1,964	10
8 x 75	5/16 x 3	7.94 x 76.20	178	456	619	656	538	698	10
8 x 100	5/16 x 4	7.94 x 101.60	231	627	851	893	738	953	10
8 x 150	5/16 x 6	7.94 x 152.40	381	1,001	1,368	1,438	1,184	1,525	10
8 x 200	5/16 x 8	7.94 x 203.20	484	1,426	1,933	2,038	1,682	2,174	10
-	3/8 x 3	9.53 x 76.20	223	531	735	780	620	827	10
-	3/8 x 4	9.53 x 101.60	271	709	972	1,025	837	1,112	10
-	3/8 x 6	9.53 x 152.40	421	1,119	1,566	1,645	1,322	1,757	10
-	3/8 x 8	9.53 x 203.20	571	1,593	2,220	2,340	1,869	2,492	10
-	3/8 x 10	9.53 x 254.00	736	2,111	2,940	3,095	2,481	3,301	10
10 x 75	-	-	248	578	803	843	679	903	10
10 x 100	-	-	293	772	1,076	1,132	907	1,208	10
10 x 150	-	-	454	1,208	1,686	1,776	1,426	1,888	10
10 x 200	-	-	636	1,704	2,370	2,494	2,006	2,659	10
10 x 250	-	-	802	2,249	3,132	3,294	2,635	3,508	10
12 x 75	1/2 x 3	12.70 x 76.20	335	838	1,202	1,263	989	1,316	10
12 x 100	1/2 x 4	12.70 x 101.60	421	1,119	1,567	1,649	1,322	1,764	10
12 x 150	1/2 x 6	12.70 x 152.40	642	1,723	2,456	2,591	2,028	2,708	10
12 x 200	1/2 x 8	12.70 x 203.20	843	2,407	3,428	3,608	2,832	3,776	10
12 x 250	1/2 x 10	12.70 x 254.00	1,285	3,370	4,713	4,967	3,965	5,270	10
14 x 100	9/16 x 4	14.29 x 101.60	519	1,438	1,933	2,038	1,696	2,174	1
14 x 150	9/16 x 6	14.29 x 152.40	796	2,174	2,919	3,071	2,549	3,272	1
14 x 200	9/16 x 8	14.29 x 203.20	1,093	3,017	4,060	4,274	3,547	4,548	1
16 x 100	5/8 x 4	15.88 x 101.60	666	1,844	2,635	2,776	2,175	2,887	1
16 x 150	5/8 x 6	15.88 x 152.40	982	2,772	3,861	4,060	3,257	4,325	1
16 x 200	5/8 x 8	15.88 x 203.20	1,327	3,788	5,412	5,699	4,460	5,920	1
-	3/4 x 4	19.05 x 101.60	921	2,565	3,619	3,809	3,015	4,016	1
-	3/4 x 6	19.05 x 152.40	1,346	3,839	5,310	5,593	4,523	6,018	1
-	3/4 x 8	19.05 x 203.20	1,841	5,154	7,277	7,660	6,060	8,067	1
20 x 100	-	-	1,006	2,794	3,948	4,157	3,285	4,376	1
20 x 150	-	-	1,465	4,183	5,916	6,231	4,928	6,564	1
20 x 200	-	-	2,003	5,575	7,888	8,306	6,571	8,746	1
25 x 150	1 x 6	25.40 x 152.40	2,266	6,377	8,908	9,381	7,502	9,969	1
25 x 200	1 x 8	25.40 x 203.20	3,081	8,502	11,876	12,503	10,003	13,292	1

(Square Toolbit blanks are with bevelled ends)

- ZEDD = (HSS With 0% Cobalt) (62-65 HRc)
- S100 = M35 (HSS With 5% Cobalt) (63-65 HRc)
- S200 = M42 (HSS With 8% Cobalt) (65-68 HRc)
- S400 = T42 (HSS With 10% Cobalt) (64-67 HRc)
- S400E = M35 with Cryogenic (Ultra Low) Heat Treatment (64-67 HRc)
- S500 = T42 with Cryogenic (Ultra Low) Heat Treatment (65-69 HRc)

HSS FLAT (RECTANGULAR) TOOLBIT BLANKS

NOMINAL SIZE			GRADES		PKT. QTY.
MM	INCH	EQUIVALENT MM	MARK III	T42	
			Price Each Rs.	Price Each Rs.	
3 x 20 x 150	1/8 x 3/4 x 6	3.18 x 19.05 x 152.40	1,056	1,649	10
3 x 25 x 150	1/8 x 1 x 6	3.18 x 25.40 x 152.40	1,508	2,356	10
5 x 25 x 150	3/16 x 1 x 6	4.76 x 25.40 x 152.40	1,658	2,892	10
6 x 12 x 100	1/4 x 1/2 x 4	6.35 x 12.70 x 101.60	637	995	10
6 x 12 x 150	1/4 x 1/2 x 6	6.35 x 12.70 x 152.40	974	1,532	10
6 x 16 x 150	1/4 x 5/8 x 6	6.35 x 15.88 x 152.40	1,161	1,883	10
6 x 20 x 150	1/4 x 3/4 x 6	6.35 x 19.05 x 152.40	1,378	2,157	10
6 x 25 x 150	1/4 x 1 x 6	6.35 x 25.40 x 152.40	1,682	2,630	10
10 x 12 x 100	3/8 x 1/2 x 4	9.53 x 12.70 x 101.60	958	1,501	10
10 x 16 x 100	3/8 x 5/8 x 4	9.53 x 15.88 x 101.60	1,063	1,665	10
10 x 16 x 150	3/8 x 5/8 x 6	9.53 x 15.88 x 152.40	1,660	2,591	10
10 x 20 x 150	3/8 x 3/4 x 6*	9.53 x 19.05 x 152.40	1,913	2,984	10
10 x 25 x 150	3/8 x 1 x 6	9.53 x 25.40 x 152.40	3,279	5,123	10
12 x 16 x 150	1/2 x 5/8 x 6	12.70 x 15.88 x 152.40	2,046	3,633	1
12 x 20 x 150	1/2 x 3/4 x 6	12.70 x 19.05 x 152.40	2,265	4,016	1
12 x 25 x 150	1/2 x 1 x 6	12.70 x 25.40 x 152.40	2,969	4,650	1
16 x 20 x 150	5/8 x 3/4 x 6	15.88 x 19.05 x 152.40	3,083	5,267	1
20 x 25 x 150	3/4 x 1 x 6	19.05 x 25.40 x 152.40	4,341	8,332	1

- Mark III - M35 (HSS with 5% Cobalt) (63-66 HRC), T42 (HSS with 10% Cobalt)

HSS PARTING TOOLBITS

NOMINAL SIZE		GRADES		PKT. QTY.
INCH	EQUIVALENT MM	MARK II	T42	
		Price Each Rs.	Price Each Rs.	
3/32 x 1/2 x 4	2.38 x 12.70 x 101.60	834	1,463	10
3/32 x 5/8 x 5	2.38 x 15.88 x 127.00	1,045	1,923	10
1/8 x 3/4 x 6*	3.18 x 19.05 x 152.40	1,332	2,361	10
1/8 x 7/8 x 6	3.18 x 22.23 x 152.40	1,559	2,883	10
3/16 x 1 x 6	4.76 x 25.40 x 152.40	1,938	3,303	10

- Mark II - M2 (HSS with 0% Cobalt) (62-65 HRC), T42 (HSS with 10% Cobalt)

ToolBit Terms - General Features

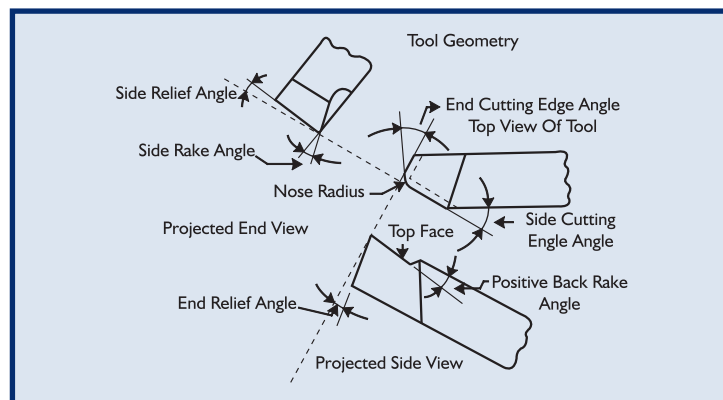

HSS TOOL BIT BLANK



New Launch

(1/4"x4") 6.35x101.60 mm

(3/8"x4") 9.53x101.60mm

MIRANDA ZEDD PLUS

MIRANDA ZEDD PLUS





HSS TOOL BIT BLANK

PRODUCT CODE	DESC	PRIZE PER PICE	PACKING QTY.
MIRTSAI05CI0505100	TOOLBIT BLANK SQ 3/16"X4" H SS ZEDD+	195	10
MIRTSAI05CI0505150	TOOLBIT BLANK SQ 3/16"X6" H SS ZEDD+	301	10
MIRTSAI05CI0606075	TOOLBIT BLANK SQ 1/4"X3" ZEDD +	169	10
MIRTSAI05CI0606100	TOOLBIT BLANK SQ 1/4"X4" ZEDD +	197	10
MIRTSAI05CI0606150	TOOLBIT BLANK SQ 1/4"X6" ZEDD +	283	10
MIRTSAI05CI0808075	TOOLBIT BLANK SQ 5/16"X3" H SS ZEDD+	187	10
MIRTSAI05CI0808100	TOOLBIT BLANK SQ 5/16"X4" H SS ZEDD+	243	10
MIRTSAI05CI0808150	TOOLBIT BLANK SQ 5/16"X6" H SS ZEDD+	400	10
MIRTSAI05CI1010075	TOOLBIT BLANK SQ 3/8"X3" ZEDD +	233	10
MIRTSAI05CI1010100	TOOLBIT BLANK SQ 3/8"X4" ZEDD +	283	10
MIRTSAI05CI1010150	TOOLBIT BLANK SQ 3/8"X6" ZEDD +	442	10
MIRTSAI05CI1010200	TOOLBIT BLANK SQ 3/8"X8" ZEDD +	599	10
MIRTSAI05CI1212075	TOOLBIT BLANK SQ 1/2"X3" ZEDD +	352	10
MIRTSAI05CI1212100	TOOLBIT BLANK SQ 1/2"X4" ZEDD +	442	10
MIRTSAI05CI1212150	TOOLBIT BLANK SQ 1/2"X6" ZEDD +	675	10
MIRTSAI05CI1212200	TOOLBIT BLANK SQ 1/2"X8" ZEDD +	883	10
MIRTSAI05CI1616100	TOOLBIT BLANK SQ 5/8"X4" ZEDD +	701	10
MIRTSAI05CI1616150	TOOLBIT BLANK SQ 5/8"X6" ZEDD +	1032	10
MIRTSAI05CI2020150	TOOLBIT BLANK SQ 3/4"X6" ZEDD +	1413	10
MIRTSAI05CI2525150	TOOLBIT BLANK SQ 1"X6" ZEDD +	2380	10
MIRTSAI05CI2525200	TOOLBIT BLANK SQ 1"X8" ZEDD +	3235	10

FEATURE

- Superior Performance
- Improved Wear Resistance
- Extended Pointing Frequency
- Special Surface Treatment
- Excellent Performance on Critical Application



MIRANDA Gold Drills



MIRANDA Super Drills

MIRANDA Gold Drills

SIZE RANGE : GOLD JOBBER DRILL

- Metric size : 1.0 mm to 20.0 mm
- Inch size : 3/64" to 25/32"

APPLICATION :

- Suitable for non ferrous metals.
- Suitable for aluminium alloy & Cast steel material.
- Suitable for material up to 25HRc.
- Suitable for general application

MIRANDA Super Drills

SIZE RANGE : SUPER JOBBER DRILL

- Metric size : 1.00 mm to 16.0 mm
- Inch size : 3/64" to 5/8"

APPLICATION :

- Drilling alloy steel up to 28-35 HRc.
- Suitable for drilling all types of stainless steel materials.
- Suitable for forged steel components.
- All Titanium alloys, Hastelloy, Inconel and Heat Resistant steels.



HSS DRILLS

HSS PARALLEL SHANK JOBBER SERIES (IS : 5101 - 1991)



SIZES			PRICE Rs. / 10 Nos.			SIZES			PRICE Rs. / 10 Nos.		
MM	INCH	DG	STD JOBBER DRILLS M2	GOLD JOBBER DRILLS M2	SUPER JOBBER DRILLS M35	MM	INCH	DG	STD JOBBER DRILLS M2	GOLD JOBBER DRILLS M2	SUPER JOBBER DRILLS M35
1.00	-	-	539	598	730	2.90	-	-	580	641	783
1.02	-	60	539	598	730	2.95	-	32	580	641	783
1.04	-	59	539	598	730	3.00	-	-	520	575	702
1.07	-	58	539	598	730	3.05	-	31*			-
1.09	-	57	539	598	730	3.10	-	-	680	755	920
1.10	-	-	539	598	730	3.17	1/8	-	680	755	920
1.18	-	56	539	598	730	3.20	-	-	698	774	942
1.19	3/64	-	539	598	730	3.26	-	30	698	774	942
1.20	-	-	539	598	730	3.30	-	-	698	774	942
1.30	-	-	539	598	730	3.40	-	-	698	774	942
1.32	-	55	539	598	730	3.45	-	29	698	774	942
1.40	-	54	539	598	730	3.50	-	-	698	774	942
1.50	-	-	539	598	730	3.57	9/64	28	698	774	942
1.51	-	53	539	598	730	3.60	-	-	1,039	1,152	1,403
1.59	1/16	-	539	598	730	3.66	-	27	1,039	1,152	1,403
1.60	-	-	539	598	730	3.70	-	-	1,039	1,152	1,403
1.61	-	52	564	626	764	3.73	-	26	1,039	1,152	1,403
1.70	-	51	564	626	764	3.80	-	25	1,039	1,152	1,403
1.78	-	50	564	626	764	3.86	-	24	1,039	1,152	1,403
1.80	-	-	564	626	764	3.90	-	-	1,039	1,152	1,403
1.85	-	49	564	626	764	3.91	-	23	1,039	1,152	1,403
1.90	-	-	564	626	764	3.97	5/32	-	1,039	1,152	1,403
1.93	-	48	564	626	764	3.99	-	22	1,039	1,152	1,403
1.98	5/64	-	564	626	764	4.00	-	-	1,039	1,152	1,403
1.99	-	47	564	626	764	4.04	-	21	1,253	1,389	1,692
2.00	-	-	564	626	764	4.09	-	20	1,253	1,389	1,692
2.06	-	46	564	626	764	4.10	-	-	1,253	1,389	1,692
2.08	-	45	564	626	764	4.20	-	-	1,253	1,389	1,692
2.10	-	-	564	626	764	4.22	-	19	1,253	1,389	1,692
2.18	-	44	564	626	764	4.30	-	18	1,253	1,389	1,692
2.20	-	-	564	626	764	4.37	11/64	-	1,253	1,389	1,692
2.26	-	43	564	626	764	4.39	-	17	1,253	1,389	1,692
2.30	-	-	564	626	764	4.40	-	-	1,253	1,389	1,692
2.37	-	42	564	626	764	4.50	-	16	1,645	1,828	2,221
2.38	3/32	-	564	626	764	4.57	-	15	1,645	1,828	2,221
2.40	-	-	564	626	764	4.60	-	-	1,645	1,828	2,221
2.44	-	41	564	626	764	4.62	-	14	1,645	1,828	2,221
2.49	-	40			-	4.70	-	13	1,645	1,828	2,221
2.50	-	-	564	626	764	4.76	3/16	-	1,645	1,828	2,221
2.53	-	39	564	626	764	4.80	-	12	1,645	1,828	2,221
2.58	-	38			-	4.85	-	11	1,808	2,006	2,441
2.60	-	-	564	626	764	4.90	-	-	1,808	2,006	2,441
2.64	-	37*	564	626	764	4.92	-	10	1,808	2,006	2,441
2.70	-	-	564	626	764	4.98	-	9	1,808	2,006	2,441
2.71	-	36	564	626	764	5.00	-	-	1,808	2,006	2,441
2.78	7/64	-	564	626	764	5.06	-	8	1,808	2,006	2,441
2.79	-	35	580	626	786	5.10	-	-	1,808	2,006	2,441
2.80	-	-	580	626	786	5.11	-	7	1,808	2,006	2,441
2.82	-	34	580	626	786	5.16	13/64	-	1,808	2,006	2,441
2.87	-	33	580	626	786	5.18	-	6	1,808	2,006	2,441

HSS DRILLS

HSS PARALLEL SHANK JOBBER SERIES (IS : 5101 - 1991)

SIZES			PRICE Rs. / 10 Nos.			SIZES			PRICE Rs. / 10 Nos.		
MM	INCH	DG	STD JOBBER DRILLS	GOLD JOBBER DRILLS	SUPER JOBBER DRILLS	MM	INCH	DG	STD JOBBER DRILLS	GOLD JOBBER DRILLS	SUPER JOBBER DRILLS
5.20*	-	-	1,808	2,006	2,441	9.13	23/64	-	5,456	6,060	7,502
5.22	-	5	1,952	2,167	2,650	9.20	-	-	5,456	6,060	7,502
5.30*	-	-	1,952	2,167	2,650	9.30	-	-	5,456	6,060	7,502
5.31	-	4	1,952	2,167	2,650	9.34	-	U	5,456	6,060	7,502
5.40*	-	-	1,952	2,167	2,650	9.40*	-	-	5,456	6,060	7,502
5.41	-	3	1,952	2,167	2,650	9.50*	-	-	5,456	6,060	7,502
5.50*	-	-	1,952	2,167	2,650	9.52	3/8*	-	6,210	6,895	8,539
5.56	7/32*	-	1,952	2,167	2,650	9.60	-	-	6,210	6,895	8,539
5.60	-	-	1,952	2,167	2,650	9.70	-	-	6,210	6,895	8,539
5.61	-	2	2,174	2,415	2,940	9.80	-	-	6,210	6,895	8,539
5.70	-	-	2,174	2,415	2,940	9.90	-	-	6,921	7,682	9,447
5.79	-	1	2,174	2,415	2,940	9.92	25/64	-	-	-	-
5.80*	-	-	2,174	2,415	2,940	10.00*	-	-	6,921	7,682	9,447
5.90*	-	-	2,174	2,415	2,940	10.10*	-	-	6,921	7,682	9,447
5.95	15/64*	-	2,174	2,415	2,940	10.20*	-	-	6,921	7,682	9,447
6.00*	-	-	2,174	2,415	2,940	10.30*	-	-	7,532	8,359	10,281
6.04	-	B	2,382	2,647	3,230	10.32	13/32*	-	7,532	8,359	10,281
6.10*	-	-	2,382	2,647	3,230	10.40	-	-	7,532	8,359	10,281
6.15	-	C	2,382	2,647	3,230	10.50*	-	-	7,532	8,359	10,281
6.20*	-	-	2,382	2,647	3,230	10.60	-	-	7,532	8,359	10,281
6.30*	-	-	2,382	2,647	3,230	10.70	-	-	7,959	8,837	10,864
6.35	1/4*	E	2,382	2,647	3,230	10.72	27/64	-	7,959	8,837	10,864
6.40	-	-	2,382	2,647	3,230	10.80*	-	-	7,959	8,837	10,864
6.50*	-	-	3,042	3,377	4,120	10.90	-	-	7,959	8,837	10,864
6.60*	-	-	3,042	3,377	4,120	11.00*	-	-	7,959	8,837	10,864
6.63	-	G	3,042	3,377	4,120	11.10*	-	-	8,884	9,859	12,127
6.70*	-	-	3,042	3,377	4,120	11.11	7/16*	-	8,884	9,859	12,127
6.75	17/64*	H	3,042	3,377	4,120	11.20	-	-	8,884	9,859	12,127
6.80*	-	-	3,042	3,377	4,120	11.30	-	-	8,884	9,859	12,127
6.90*	-	-	3,328	3,692	4,493	11.40	-	-	8,884	9,859	12,127
7.00*	-	J	3,328	3,692	4,493	11.50*	-	-	9,360	10,388	12,776
7.10	-	-	3,328	3,692	4,493	11.51	29/64	-	9,360	10,388	12,776
7.14	9/32*	K	3,328	3,692	4,493	11.60	-	-	9,360	10,388	12,776
7.20	-	-	3,328	3,692	4,493	11.70	-	-	9,360	10,388	12,776
7.30*	-	-	3,516	3,905	4,760	11.80*	-	-	9,360	10,388	12,776
7.40	-	-	3,516	3,905	4,760	11.90	-	-	10,003	11,109	13,654
7.50*	-	-	3,516	3,905	4,760	11.91	15/32	-	10,003	11,109	13,654
7.54	19/64*	-	3,818	4,238	5,162	12.00*	-	-	10,003	11,109	13,654
7.60	-	-	3,819	4,238	5,161	12.10	-	-	10,003	11,109	13,654
7.70	-	-	3,819	4,238	5,161	12.20	-	-	10,003	11,109	13,654
7.80*	-	-	3,819	4,238	5,161	12.30	31/64	-	10,610	11,779	14,483
7.90*	-	-	4,173	4,632	5,640	12.40	-	-	10,610	11,779	14,483
7.94	5/16*	-	4,173	4,632	5,640	12.50*	-	-	10,610	11,779	14,483
8.00*	-	-	4,173	4,632	5,640	12.60	-	-	10,610	11,779	14,483
8.03	-	O	4,173	4,632	5,640	12.70	1/2*	-	11,197	12,429	15,284
8.10*	-	-	4,173	4,632	5,640	12.80	-	-	11,197	12,429	15,284
8.20*	-	-	4,173	4,632	5,640	12.90	-	-	11,197	12,429	15,284
8.30	-	-	4,958	5,503	6,830	13.00*	-	-	11,197	12,429	15,284
8.33	21/64*	-	4,958	5,503	6,830	13.10	33/64	-	13,932	15,465	19,017
8.40	-	-	4,958	5,503	6,830	13.20	-	-	13,932	15,465	19,017
8.50*	-	-	4,958	5,503	6,830	13.30	-	-	13,932	15,465	19,017
8.60*	-	-	4,958	5,503	6,830	13.40	-	-	13,932	15,465	19,017
8.70*	-	-	4,958	5,503	6,830	13.49	17/32*	-	14,816	16,448	20,224
8.73	11/32*	-	5,287	5,869	7,270	13.50*	-	-	14,816	16,448	20,224
8.80	-	-	5,287	5,869	7,270	13.60	-	-	14,816	-	20,224
8.90	-	-	5,287	5,869	7,270	13.70	-	-	14,816	-	20,224
9.00*	-	-	5,287	5,869	7,270	13.80	-	-	14,816	16,448	20,224
9.10	-	-	5,456	6,060	7,453	13.89	35/64	-	16,090	17,864	21,963

SIZES			PRICE Rs. / 10 Nos.		
MM	INCH	DG	STD JOBBER DRILLS	GOLD JOBBER DRILLS	SUPER JOBBER DRILLS
13.90	-	-	16,090	17,863	21,947
14.00*	-	-	16,090	17,863	21,947
14.25	-	-	16,090	17,863	21,947
14.29	9/16	-	16,866	18,723	23,005
14.50*	-	-	18,160	18,723	24,770
14.68	37/64	-	18,160	20,160	24,770
14.75	-	-	18,160	20,160	24,770
15.00*	-	-	18,160	20,160	24,770
15.08	19/32	-	18,160	20,160	24,770
15.25	-	-	18,160	20,160	24,770

SIZES			PRICE Rs. / 10 Nos.		
MM	INCH	DG	STD JOBBER DRILLS	GOLD JOBBER DRILLS	SUPER JOBBER DRILLS
15.50*	-	-	19,712	21,880	27,104
15.75	-	-	19,712	21,880	27,104
15.87	5/8*	-			-
16.00*	-	-	19,712	21,880	27,104
17.00	-	-	20,866	23,164	
17.46	11/16	-	20,866	23,164	
18.00	-	-	22,584	25,071	
19.00	-	-	23,878	26,506	
19.05	3/4	-	23,878	26,506	
20.00	-	-			

DRILL SET (IS : 5101 - 1991)

DRILL SET	PRICE Rs. / SET	
	STD. JOBBER DRILLS	GOLD JOBBER DRILLS
1.50 TO 6.50 MM (13 Pcs.)	1,884	2,093
1.00 TO 10.00 MM (19 Pcs.)	5,249	
1.00 TO 13.00 MM (25 Pcs.)	11,115	12,337
1/16 TO 1/4 INCH (13 Pcs.)	1,884	2,093
1/16 TO 3/8 INCH (21 Pcs.)	5,601	6,226
1/16 TO 1/2 INCH (29 Pcs.)	12,354	

HSS PARALLEL SHANK STUB SERIES (IS : 5100 - 1969)

SIZES		PRICE Rs. / 10 Nos.		
MM	INCH	STD. STUB DRILLS	GOLD STUB DRILLS	SUPER STUB DRILLS
1.50		558	618	-
1.60		558	618	-
1.90		-		-
2.00		558	618	-
2.20		558	618	-
2.50		558	618	-
2.78	7/64	558	618	-
2.90		606	675	-
3.00	-	560	624	801
3.17	1/8*	662	736	944
3.20	-	699	774	995
3.50	-	699	774	995
3.57	9/64	699	774	995
3.97	5/32*	992	1,100	1,415
4.00	-	992	1,100	1,415
4.20	-	1,116	1,238	1,590
4.50	-	1,475	1,641	2,106
4.76	3/16	1,475	1,641	2,106
5.00	-	1,580	1,753	2,251
5.16	13/64	1,580	1,753	2,251
5.50	-	1,712	1,901	2,438
5.56	7/32	1,712		2,438
6.00	-	1,938	2,147	2,760

SIZES		PRICE Rs. / 10 Nos.		
MM	INCH	STD. STUB DRILLS	GOLD STUB DRILLS	SUPER STUB DRILLS
6.35	1/4	2,164	2,402	3,086
6.50	-	2,654	2,946	3,783
6.75	17/64	2,654		3,783
6.80	-	2,654	2,946	3,783
7.00	-	2,916	3,235	4,157
7.14	9/32*	2,916	3,235	4,157
7.50	-	3,022	3,354	4,310
7.94	5/16*	3,660	4,064	5,220
8.00	-	3,595	3,992	5,127
8.50	-	4,500	4,996	6,419
9.00	-	4,700	5,217	6,703
9.50	-	4,959	5,504	7,070
9.52	3/8	5,179	5,749	7,384
10.00	-	6,338	7,039	9,041
10.50	-	6,819	7,570	-
11.00	-	7,678	8,523	10,947
11.11	7/16	8,523	8,879	11,406
12.00	-	9,060	10,058	12,920
12.70	1/2	10,033	11,136	14,308
13.00	-	10,033	11,136	14,308
14.00	-	13,675	15,177	-
15.00	-	15,399	17,093	-
16.00	-	16,694	18,533	-

HSS DRILLS

HSS PARALLEL SHANK LONG SERIES (IS : 5102 - 1969)

SIZES		PRICE Rs. / PIECE	SIZES		PRICE Rs. / PIECE	SIZES		PRICE Rs. / PIECE
MM	INCH		MM	INCH		MM	INCH	
1.00	-	300	3.57	9/64	390	7.00	-	1,090
1.10	-	300	3.70	-	422	7.20	-	1,090
1.19	-	300	3.80	-	422	7.50	-	1,090
1.20	-	300	3.97	5/32	422	7.80	-	1,090
1.30	-	300	4.00	-	422	7.94	5/16	1,122
1.40	-	300	4.10	-	422	8.00	-	1,122
1.50	-	300	4.20	-	422	8.10	-	1,122
1.59	1/16	300	4.30	-	422	8.20	-	1,122
1.60	-	300	4.50	-	422	8.50	-	1,122
1.70	-	300	4.76	3/16	422	9.00	-	1,242
1.80	-	300	4.80	-	422	9.50	-	1,242
1.90	-	300	4.90	-	489	9.52	3/8	1,242
1.98	5/64	300	5.00	-	489	9.80	-	1,447
2.00	-	300	5.10	-	489	10.00	-	1,564
2.10	-	300	5.16	13/64	489	10.20	-	1,637
2.20	-	300	5.20	-	489	10.50	-	1,684
2.30	-	384	5.30	-	573	11.00	-	1,910
2.38	3/32	384	5.50	-	573	11.50	-	1,739
2.40	-	384	5.56	7/32	573	11.80	-	1,739
2.50	-	384	5.60	-	620	12.00	-	1,739
2.60	-	384	5.80	-	620	12.50	-	2,412
2.70	-	384	5.90	-	620	12.70	1/2	2,680
2.78	7/64	384	5.95	15/64	620	13.00	-	2,680
2.80	-	384	6.00	-	620	13.50	-	2,680
2.90	-	384	6.10	-	702	14.00	-	2,680
3.00	-	390	6.35	1/4	644	14.29	9/16	2,680
3.10	-	390	6.50	-	902	14.50	-	2,804
3.17	1/8	390	6.60	-	1,090	15.00	-	2,804
3.20	-	390	6.75	17/64	1,090	15.50	-	2,916
3.30	-	390	6.80	-	1,090	15.87	5/8	2,916
3.50	-	390	6.90	-	1,090	16.00	-	

Note : Minimum order value required is Rs.20000/- nett.

HSS PARALLEL SHANK - EXTRA LONG SERIES

SIZES		OAL MM FL MM	PRICE Rs. / PIECE						
MM	INCH		150	175	200	225	250	300	350
3.00	1/8	-	1,133	1,365	1,561	1,840	2,206	2,645	-
3.50	-	-	1,179	1,373	1,570	2,131	2,364	3,121	-
4.00	5/32	-	1,132	1,373	1,570	2,134	2,372	3,121	4,296
4.50	-	-	1,140	1,407	1,607	2,137	2,377	3,345	4,405
5.00	3/16	-	1,169	1,439	1,637	2,177	2,427	3,422	
5.50	7/32	-	1,235	1,514	1,739	2,337	2,589	3,429	4,517
6.00	-	-	1,235	1,551	1,768	2,395	2,663	3,520	5,238
6.50	1/4	-	-	-	2,141	-	3,092	3,987	5,238
7.00	-	-	-	-	2,248	-	3,364	4,035	5,861
7.50	9/32	-	-	-	2,372	-	3,555	4,269	5,883
8.00	5/16	-	-	-	2,508	-	3,767	4,340	6,018
8.50	11/32	-	-	-	2,595	-	3,834	4,470	5,476
9.00	-	-	-	-	2,603	-	3,834	4,470	5,476
9.50	3/8	-	-	-	2,678	-	3,843	4,608	
10.00	-	-	-	-	2,720	-	3,924	5,207	6,396
10.50	13/32	-	-	-	2,955	-	4,077	5,476	
11.00	7/16	-	-	-	-	-	4,112	5,597	7,237
11.50	-	-	-	-	-	-	4,310	5,703	7,523
12.00	15/32	-	-	-	-	-	4,321	5,720	
12.50	1/2	-	-	-	-	-		6,064	

Note : Other details will be maintained as per IS : 7823 - 2005.
Minimum order value required is Rs.20000/- nett.

HSS DRILLS
HSS CENTRE DRILLS



TYPE 'A' & 'R' IS : 6708/6710 - 1977			TYPE 'B' IS : 6709 - 1977			B.S. 328 (PART 2) 1950			
PILOT DIA MM	BODY DIA MM	PRICE RS./PIECE	PILOT DIA MM	BODY DIA MM	PRICE RS./PIECE	SIZE B.S. NO.	PILOT DIA INCH	BODY DIA INCH	PRICE RS./PIECE
1.00	3.15	268	1.00	4.00	439	BS-1	3/64"	1/8"	268
1.25	3.15	268	1.25	5.00	473	BS-2	1/16"	3/16"	268
1.60	4.00	268	1.60	6.30	553	BS-3	3/32"	1/4"	307
2.00	5.00	268	2.00	8.00	777	BS-4	1/8"	5/16"	478
2.50	6.30	307	2.50	10.00	991	BS-5	3/16"	7/16"	631
3.15	8.00	478	3.15	11.20	1,326	BS-6	1/4"	5/8"	1,185
4.00	10.00	591	4.00	14.00	1,776	-	-	-	-
5.00	12.50	1,005	-	-	-	-	-	-	-
6.30	16.00	1,185	-	-	-	-	-	-	-
-	-	-	-	-	-	-	-	-	-

HSS TAPER SHANK DRILLS
IS : 5103 - 1969

SIZES		PRICE RS. / PIECE		SIZES		PRICE RS. / PIECE		SIZES		PRICE RS. / PIECE	
MM	INCH	REGULAR	SUPER	MM	INCH	REGULAR	SUPER	MM	INCH	REGULAR	SUPER
3.00	-			10.20	-	1,270	1,721	17.25	-	3,208	4,347
3.20	-	508	688	10.50	-	1,504	2,038	17.46	11/16*	3,208	4,347
3.50	-	484	656	10.80	-	1,573	2,131	17.50	-	3,325	4,505
3.80	-	508	688	11.00	-	1,573	2,131	17.75	-	3,364	4,558
4.00	-	484	656	11.11	7/16*	1,573	2,131	18.00	-	3,518	4,767
4.20	-	653	885	11.20	-	1,617	2,191	18.25	-	3,518	4,767
4.50	-	653	885	11.50	-	1,617	2,191	18.26	23/32	3,518	4,767
4.76	3/16	653	885	11.80	-	1,617	2,191	18.50	-	3,518	4,767
4.80	-	672	911	12.00	-	1,642	2,225	18.75	-	3,549	4,809
5.00	-	653	885	12.20	-	1,642	2,225	19.00	-	3,549	4,809
5.20	-	672	911	12.50	-	1,642	2,225	19.05	3/4*	3,549	
5.50	-	653	885	12.70	1/2*	1,642	2,225	19.25	-	3,728	5,051
5.80	-	672	911	12.80	-	2,274	3,081	19.50	-	3,728	5,051
6.00	-	653	885	13.00	-	2,274	3,081	19.75	-	3,728	5,051
6.20	-	741	1,004	13.20	-	2,381	3,226	19.84	25/32	3,728	5,051
6.35	1/4*	729	988	13.49	17/32*	2,381	3,226	20.00	-	4,007	5,429
6.50	-	745	1,009	13.50	-	2,548	3,453	20.25	51/64	4,048	5,485
6.75	17/64*			13.80	-	2,548	3,453	20.50	-	4,048	5,485
6.80	-	755	1,023	14.00	-	2,548	3,453	20.64	13/16*	4,048	5,485
7.00	-	745	1,009	14.25	-	2,728	3,696	20.75	-	4,232	5,734
7.20	-	755	1,023	14.29	9/16*	2,728	3,696	21.00	-	4,232	5,734
7.50	-	745	1,009	14.50	-	2,849	3,860	21.25	-	4,346	
7.80	-	755	1,023	14.75	-	2,849	3,860	21.43	27/32		
7.94	5/16*	745	1,009	15.00	-	2,849	3,860	21.50	-	4,463	6,047
8.00	-	745	1,009	15.25	-	2,895		21.75	-	4,463	6,047
8.20	-			15.50	-	2,895	3,923	22.00	-	4,549	6,164
8.50	-	970	1,314	15.75	-	2,895	3,923	22.22	7/8	4,549	6,164
8.80	-	1,174	1,591	15.87	5/8*	2,895		22.25	-	4,959	6,719
9.00	-	1,067	1,446	16.00	-	2,960	4,011	22.50	-	4,959	6,719
9.20	-	1,174	1,591	16.25	-	2,960	4,011	22.75	-	5,055	6,850
9.50	-	1,067	1,446	16.50	-	3,164	4,287	23.00	29/32	5,055	6,850
9.52	3/8*	1,067	1,446	16.67	21/32	3,164	4,287	23.25	-	5,301	7,183
9.80	-	1,257	1,703	16.75	-	3,164	4,287	23.50	-	6,033	8,175
10.00	-	1,135	1,538	17.00	-	3,164	4,287	23.75	-	6,033	8,175

Note : • For Super Series : Minimum order value required is Rs. 20000/- nett or
 • MOQ : From 3mm to 10mm - 50 Nos., From 20mm to 32mm - 10 Nos. Above 50mm - 2 Nos.
 From 10mm to 20mm - 30 Nos. From 32mm to 50mm - 5 Nos.

SIZES		PRICE RS. / PIECE	
MM	INCH	REGULAR	SUPER
24.00*	-	6,191	8,389
24.25	-	6,303	8,541
24.50*	-	6,303	
24.75	-	6,598	8,940
25.00*	63/64	6,598	8,940
25.40	1*	6,688	9,062
25.50*	-	7,262	
25.75	-	7,262	9,840
26.00*	-	7,326	9,927
26.25	-	7,876	10,672
26.50*	-	8,054	10,913
27.00*	-	8,312	11,263
27.25	-	8,329	11,286
27.50	-	8,329	
27.75	-		
28.00*	-	9,152	12,401
28.25	-	9,152	12,401
28.50	-	9,152	12,401
28.58	1.1/8	9,152	12,401
28.75	-	9,420	12,764
29.00*	-	9,558	12,951
29.25	-	9,558	12,951
29.50	-	9,607	13,017
29.75	-		
30.00*	-	9,808	13,290
30.25	-	11,151	15,110
30.50*	-	11,151	
30.75	-	11,331	15,354
31.00*	-	12,607	
31.50	-	13,175	17,852
31.75	1.1/4	13,175	17,852
32.00*	-	14,424	19,545
32.50	-	14,424	19,545
33.00*	-	14,785	
33.34	1.5/16		
33.50	-	15,294	20,723
34.00*	-	15,590	21,124
34.50	-	17,068	23,127
34.93	1.3/8	17,205	23,313
35.00*	-	17,205	23,313
35.50	-	18,253	24,733
36.00*	-	18,523	25,099

SIZES		PRICE RS. / PIECE	
MM	INCH	REGULAR	SUPER
36.50	1.7/16	18,883	25,586
37.00*	-	19,337	
37.50	-	20,616	27,935
38.00*	-	20,935	28,367
38.10	1.1/2	20,935	28,367
38.50	1.33/64	21,568	29,225
39.00*	-	22,847	
39.50	-	22,847	30,958
39.69	1.9/16	22,847	30,958
40.00*	-	23,440	31,761
40.50	-	24,797	33,600
41.00	-	24,797	33,600
41.27	1.5/8	24,797	33,600
41.50	-	25,768	34,916
42.00*	-	25,768	
42.50	-	26,424	35,805
43.00	-	27,381	
43.50	-	27,381	37,101
44.00	-	28,345	
44.45	1.3/4	28,345	38,407
44.50	-	28,345	38,407
45.00*	-	29,009	
45.50	-	30,325	41,090
46.00	-	30,325	41,090
46.50	-		
47.00	-	31,847	43,153
47.50	-	32,517	44,061
47.62	1.7/8	32,517	44,061
48.00	-	35,459	48,047
48.50	-	35,724	48,406
49.00	-	35,724	48,406
49.50	-	36,100	48,916
50.00	-	36,100	
50.50	-	38,027	51,527
50.80	2	38,027	51,527
51.00	-	51,622	69,948
52.00	-	51,622	69,948
52.50	-	67,185	91,036
53.00	-	67,185	91,036
53.50	-	67,185	91,036
53.97	2.1/8	67,185	91,036
54.00	-	67,185	91,036

SIZES		PRICE RS. / PIECE	
MM	INCH	REGULAR	SUPER
54.50	-	70,577	95,632
55.00	-	70,577	95,632
55.50	-	70,577	95,632
55.56	2.3/16	70,577	95,632
56.00	-	73,541	99,648
56.50	-	73,541	99,648
57.00	-	73,541	99,648
57.15	2.1/4	73,541	99,648
57.50	-	80,261	1,08,754
58.00	-	80,261	1,08,754
58.50	-	80,261	1,08,754
58.74	2.5/16	80,261	1,08,754
59.00	-	81,794	1,10,831
59.50	-	81,794	1,10,831
60.00	-	81,794	1,10,831
60.32	2.3/8	81,794	1,10,831
60.50	-	86,942	1,17,806
61.00	-	86,942	1,17,806
61.50	-	86,942	1,17,806
62.00	-	86,942	1,17,806
62.50	-	86,942	1,17,806
63.00	-	88,406	1,19,790
63.50	2.1/2	88,406	1,19,790
64.00	-	97,702	1,32,386
65.00	-	97,702	1,32,386
65.09	2.9/16	97,702	1,32,386
66.00	-	98,436	1,33,381
66.67	2.5/8	98,436	1,33,381
67.00	-	1,00,834	1,36,630
68.00	-	1,08,063	1,46,425
69.00	-	1,17,142	1,58,727
69.85	2.3/4	1,17,142	1,58,727
70.00	-	1,17,142	1,58,727
71.00	-	1,26,381	1,71,246
71.50	-	1,26,381	1,71,246
72.00	-	1,28,866	1,74,613
73.00	-	1,28,866	1,74,613
73.02	2.7/8	1,28,866	1,74,613
74.00	-	1,37,132	1,85,814
75.00	-	1,38,908	1,88,220
76.00	-	1,38,908	1,88,220
76.20	3	1,38,908	1,88,220

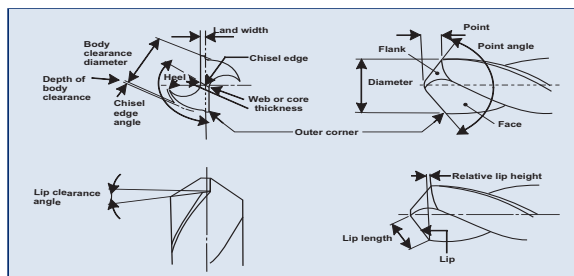

Note : • For Super Series : Minimum order value required is Rs. 20000/- nett or
 • MOQ : From 3mm to 10mm - 50 Nos., From 20mm to 32mm - 10 Nos. Above 50mm - 2 Nos.
 From 10mm to 20mm - 30 Nos. From 32mm to 50mm - 5 Nos.

HSS DRILLS
HSS TAPER SHANK TWIST DRILLS (LONG SERIES)
IS : 8305 - 1976 (Type N)



SIZES		OAL	PRICE Rs. / PIECE
MM	INCH	MM	
5.00	-	155	1,596
5.16	13/64	155	1,596
5.56	7/32	161	1,781
6.00	-	161	1,781
6.35	1/4	167	1,992
6.50	-	167	1,992
7.00	-	174	2,140
7.50	-	174	2,212
7.94	5/16	181	2,337
8.00	-	181	
8.50	-	181	2,387
9.00	-	188	2,584
9.50	-	188	2,644
9.52	3/8	197	2,644
10.00	-	197	3,006
10.50	-	197	3,092
11.00	-	206	
11.11	7/16	206	3,274
11.50	-	206	3,274
12.00	-	215	3,888
12.50	-	215	4,098
12.70	1/2	215	4,098
13.00	-	215	4,098
13.49	17/32	223	
13.50	-	223	4,486
14.00	-	223	4,668
14.29	9/16	245	5,827
14.50	-	245	5,827
15.00	-	245	
15.50	-	251	6,096
15.87	5/8	251	6,253
16.00	-	251	
16.50	-	257	
17.00	-	257	
17.50	-	263	
18.00	-	263	
18.50	-	269	7,184
19.00	-	269	7,298
19.05	3/4	275	7,298

SIZES		OAL	PRICE Rs. / PIECE
MM	INCH	MM	
19.50	-	275	7,497
20.00	-	275	7,624
20.50	-	282	7,750
21.00	-	282	7,894
21.43	27/32	289	9,169
21.50	-	289	9,169
21.75	-	289	9,356
22.00	-	289	
22.22	7/8	289	9,992
22.50	-	296	9,992
23.00	-	296	10,470
23.50	-	319	12,794
24.00	-	327	12,794
24.50	-	327	13,354
25.00	-	327	
25.40	1	335	13,836
25.50	-	335	13,836
26.00	-	335	14,391
26.50	-	335	14,809
27.00	-	343	17,553
27.50	-	343	18,110
28.00	-	343	18,673
28.50	-	351	19,270
29.00	-	351	19,813
29.50	-	351	20,365
30.00	-	351	20,942
30.50	-	360	21,494
31.00	-	360	21,494
31.50	-	360	21,650
32.00	-	397	25,903
32.50	-	397	27,019
33.00	-	397	27,019
34.00	-	406	28,196
34.50	-	406	29,432
35.00	-	406	29,432
36.00	-	416	32,254
38.00	-	426	36,236
38.10	1.1/2	426	37,423
40.00	-	426	38,907

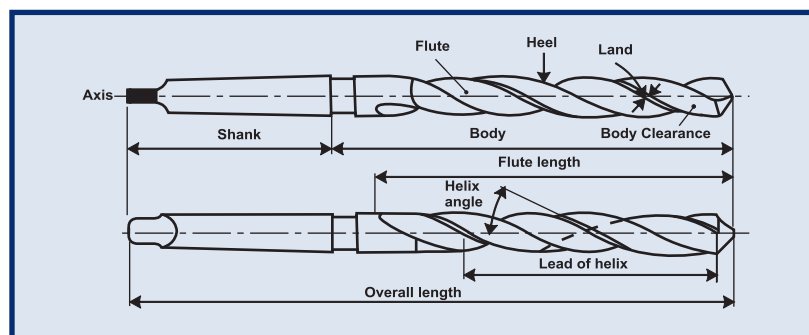

HSS TAPER SHANK TWIST DRILLS (EXTRA LONG SERIES)

IS : 7822 - 2005

SIZES		OVERALL LENGTH IN MM									
		200	225	250	275	300	315	325	350	375	400
MM	INCH	PRICE RS./PIECE									
10.00	-	3,004	3,401		4,482	5,162	5,636	-	-	-	-
10.50	-		3,530	4,098	4,738		5,877	6,176	7,065	-	-
11.00	-	3,158	3,641	4,135	4,810	5,529	6,072	6,338	7,190	-	-
11.50	7/16	3,274	3,716	4,244	4,936		6,176	6,455	7,386	-	-
12.00	-	-		4,425	5,127		6,418		7,624	-	-
12.50	1/2	-	4,098	4,576	5,314	6,057	6,620	6,924	7,984	-	-

SIZES		OVERALL LENGTH IN MM									
		250	275	300	315	325	350	375	400	450	500
MM	INCH	PRICE RS./PIECE									
13.00	-		6,219		8,030	8,066	9,178	-	-	-	-
13.50	-		6,346	7,600	8,229	8,208	9,351	-	-	-	-
14.00	-	5,790	6,535	7,739	8,397	8,343	9,537	10,774		-	-
14.50	9/16	5,827	6,621	7,849	8,440	8,463	9,715	10,958	12,310	16,152	20,380
15.00	-	5,958	6,772	8,044	8,620	8,667		11,117	12,504		20,589
15.50	-	6,096	6,923	8,118	8,791	8,785	10,065	11,329	12,672	16,502	20,768
16.00	5/8	6,253	7,040	8,279	8,914	8,948		11,502	12,934	16,785	
16.50	-	6,360	7,136		9,081	9,087	10,389	11,715		16,966	21,124
17.00	-		7,306	8,527	9,191			11,875		17,172	21,321
17.50	11/16	-	-		9,369		10,760	12,074	13,509		21,523
18.00	-	-	-	8,865	9,576	9,538	10,931	12,285	13,759	17,553	21,731
18.50	-	-	-	9,006	9,694	9,710	11,026	12,431		17,752	21,940

SIZES		OVERALL LENGTH IN MM									
		300	315	325	350	375	400	425	450	475	500
MM	INCH	PRICE RS./PIECE									
19.00	3/4	8,749	9,388	9,852	11,213	12,621	14,158	15,948	17,958	19,886	21,879
19.50	-		9,493	9,951	11,418	12,872	14,446	16,152	18,089	20,124	22,279
20.00	-	9,010	9,651	10,140	11,548	13,045		16,466		20,347	
20.50	-	9,180	9,828	10,282	11,740	13,206	14,875	16,667	18,669	20,658	22,876
21.00	13/16	9,343	10,017	10,456		13,481	15,121	17,026	18,975	21,039	23,239
21.50	-		10,183	10,631		13,738	15,408	17,277	19,351	21,418	23,705
22.00	-	9,743	10,453	10,932		13,978		17,553	19,657	21,758	24,084
22.50	7/8	9,992	10,672	11,170	12,639	14,158	15,833	17,852	19,948	22,137	24,491
23.00	-	10,470	11,172	11,585		14,470	16,117	18,110	20,328	22,463	24,855
23.50	-	11,502	-	12,793	14,021	15,413	16,666	18,725	20,903	23,138	25,624
24.00	15/16	11,502	-	12,793	14,159	15,611		19,318	21,564	23,766	26,307
24.50	-	11,861	-	13,354	14,806	16,152	17,842	19,948	22,179	24,465	27,019
25.00	-	-	-	13,840		16,785	18,387	20,514	22,821	25,143	27,772
25.50	1	-	-	-	15,826	17,277	18,934	21,104	23,423	25,819	28,427
26.00	-	-	-	-	16,467		19,552	21,731	24,111	26,490	29,178
26.50	-	-	-	-	16,966	18,426	20,094	22,333	24,731	27,114	29,893
27.00	1.1/16	-	-	-	17,553	19,076	20,691	22,926	25,350	27,821	30,595
27.50	-	-	-	-	18,110	19,559	21,203	23,533	25,985	28,466	31,283
28.00	-	-	-	-	18,673	20,124		24,111	26,616	29,751	32,040
28.50	1.1/8	-	-	-		20,717		24,670	27,265	29,849	32,698

SIZES		OVERALL LENGTH IN MM									
		300	315	325	350	375	400	425	450	475	500
MM	INCH	PRICE RS./PIECE									
29.00	-	-	-	-	19,813	21,288	22,972	25,300	27,915	30,477	33,439
29.50	-	-	-	-	20,357	21,825	23,518		28,507	31,163	34,175
30.00	1.3/16	-	-	-		22,410	24,099	26,490	29,150	31,823	34,845
31.00	1.1/4	-	-	-	21,494	22,970	24,685	27,144	29,907	32,654	35,829
32.00	-	-	-	-	21,652	23,423		28,466	31,352	34,175	
33.00	1.5/16	-	-	-	-	-		29,733	32,751	35,698	39,128
34.00	-	-	-	-	-	-	28,199	30,993	34,157	37,247	40,811
35.00	1.3/8	-	-	-	-	-	29,432	32,356	35,563	38,806	
36.00	-	-	-	-	-	-	30,595	33,583	36,934	40,302	44,138
37.00	1.7/16	-	-	-	-	-	31,755	34,845	38,338	41,814	45,746
38.00	1.1/2	-	-	-	-	-	32,967	36,235	39,826	43,380	47,485
39.00	-	-	-	-	-	-	34,176	37,819	41,096	44,761	48,901
40.00	-	-	-	-	-	-	-	38,905	42,540	46,273	50,509
41.00	1.5/8	-	-	-	-	-	-	-	-	-	
42.00	-	-	-	-	-	-	-	-	-	-	54,503
43.00	-	-	-	-	-	-	-	-	-	-	56,915
44.00	-	-	-	-	-	-	-	-	-	-	59,294
45.00	1.3/4	-	-	-	-	-	-	-	-	-	61,710
46.00	1.13/16	-	-	-	-	-	-	-	-	-	64,319
47.00	-	-	-	-	-	-	-	-	-	-	66,919
48.00	1.7/8	-	-	-	-	-	-	-	-	-	69,530
49.00	1.15/16	-	-	-	-	-	-	-	-	-	-
50.00	-	-	-	-	-	-	-	-	-	-	-

**MASONRY DRILLS - CARBIDE TIPPED
(GROUND FLUTED & BRIGHT PLATED)**



SIZES		FLUTE LENGTH	OVERALL LENGTH	PRICE RS. / PIECE
MM	INCH			STD DRILLS
3	1/8"	40	76	60
4	5/32"	45	85	69
5	3/16"	45	90	76
5.5	7/32"	45	90	93
6	15/64"	60	110	99
6.5	1/4"	60	110	99
7	9/32"	60	110	186
8	5/16"	80	120	161
9	11/32"	80	120	188
10	3/8"	80	120	188
11	7/16"	115	160	262
12	15/32"	115	160	233
13	1/2"	115	160	233

HSS ENDMILLS

**HSS PARALLEL SHANK ENDMILLS
IS 6353 - 1991 & BS-122 (PART-1) 1953**

Dia		Price Each Rs.		Dia		Price Each Rs.		Dia		Price Each Rs.		Dia		Price Each Rs.	
MM	INCH	M2	M42	MM	INCH	M2	M42	MM	INCH	M2	M42	MM	INCH	M2	M42
3*	1/8	760	1,215	15*	-	1,431	2,293	27	-	3,128	5,001	40	-	7,465	11,941
4*	5/32	760	1,215	16*	5/8	1,440	2,304	28	1.1/8	3,651	5,840	41	1.5/8	7,465	11,941
5*	3/16	760	1,215	17	-	1,576	2,523	29	-	3,651	5,840	42	-	8,491	13,587
6*	1/4*	851	1,360	18*	-	1,747	2,798	30*	-	4,015	6,428	43	-	8,491	13,587
7	-	961	1,538	19*	3/4	1,747	2,798	32	1.1/4	4,379	7,008	45	1.3/4	9,513	15,217
8*	5/16	961	1,538	20*	13/16	1,935	3,095	33	-	4,850	7,759	46	-	9,513	15,217
9*	3/8*	961	1,538	21	-	2,177	3,489	34	1.3/8	5,289	8,460	47	1.7/8	10,491	16,784
10*	-	961	1,538	22*	7/8	2,195	3,511	35	-	5,289	8,460	48	-	10,491	16,784
11	7/16	961	1,538	23	-	2,384	3,814	36	-	5,766	9,227	49	-	10,491	16,784
12*	1/2*	993	1,589	24*	-	2,384	3,814	37	-	6,212	9,934	50	-	11,509	18,411
13	-	1,131	1,805	25*	1.0	2,559	4,090	38	-	6,624	10,595	-	-	-	-
14*	9/16	1,231	1,975	26	-	2,659	4,253	39	-	7,022	11,235	-	-	-	-

**HSS PARALLEL SHANK SLOT DRILLS
IS 6352 - 1991 & BS (PART - 1) 1953**

Dia		Price Each Rs.		Dia		Price Each Rs.		Dia		Price Each Rs.		Dia		Price Each Rs.	
MM	INCH	M2	M42	MM	INCH	M2	M42	MM	INCH	M2	M42	MM	INCH	M2	M42
3	1/8	926	1,483	14	9/16	1,440	2,304	26	-	3,903	6,247	43	-	8,981	14,371
4	5/32	926	1,483	15	-	1,623	2,600	30	-	4,794	7,669	44	-	8,981	14,371
5*	3/16	926	1,483	16	5/8	1,621	2,594	32	1.1/4	4,794	7,669	45	1.3/4	8,981	14,371
6*	1/4	993	1,592	18	-	1,994	3,186	34	1.3/8	5,766	9,227	46	-	9,971	15,953
7	-	993	1,592	20*	3/4	1,994	3,186	35	-	5,766	9,227	47	1.7/8	9,971	15,953
8*	5/16	993	1,592	21	13/16	2,327	3,722	36	-	6,189	9,903	48	-	9,971	15,953
9	3/8	993	1,592	22	7/8	2,327	3,722	38	1.1/2	6,677	10,681	49	-	10,936	17,499
10*	-	1,027	1,641	23	-	2,764	4,424	40	-	7,139	11,423	50	2.0	10,936	17,499
11	-	1,027	1,641	24	-	2,764	4,424	41	-	8,080	12,927	-	-	-	-
12	1/2	1,126	1,801	25	1.0	2,764	4,424	42	-	8,080	12,927	-	-	-	-

**HSS PARALLEL SHANK ENDMILLS - : LONG SERIES
IS 6353 - 1991**

Dia		Price Each Rs.		Dia		Price Each Rs.		Dia		Price Each Rs.		Dia		Price Each Rs.	
MM	M2	M42	MM	M2	M42	MM	M2	M42	MM	M2	M42	MM	M2	M42	
3	987	1,580	9	1,251	1,998	20	2,517	4,026	32	5,693	9,108	44	10,936	17,499	
4	987	1,580	10*	1,251	1,998	22	2,855	4,566	33	6,306	10,088	45	10,936	17,499	
5	987	1,580	12*	1,290	2,065	25	3,326	5,322	36	7,496	11,994	46	10,936	17,499	
6	1,108	1,771	14	1,604	2,564	26	3,456	5,529	40	9,704	15,522	47	10,936	17,499	
7	1,251	1,998	16	1,872	2,993	28	4,747	7,594	45	12,364	19,785	48	10,936	17,499	
8	1,251	1,998	18	2,271	3,634	30	5,223	8,356	50	14,961	23,937	49	10,936	17,499	

**HSS PARALLEL SHANK ROUGHING END MILLS -M42
4 FLUTES - COARSE PITCH - TO IS : 6353 -1991 / BS:122**

SIZE		PRICE RS. / PIECE	
MM	INCH	STANDARD SERIES	LONG SERIES
6	1/4	2,748	3,735
8	5/16	2,748	3,735
10	3/8	2,748	3,735
12	1/2	2,748	3,735
14	-	4,178	5,683
16	5/8	4,861	6,621
18	-	5,925	7,390
20	3/4	6,614	9,004
22	7/8	7,094	9,662
25	1	8,363	11,402
28	1.1/8	11,278	15,365
30	-	13,541	18,454

HSS REAMERS



REFERENCE STANDARDS

HSS HAND REAMERS WITH PARALLEL SHANK
HSS MACHINE REAMERS WITH TAPER SHANK
HSS CHUCKING REAMERS WITH PARALLEL SHANK
HSS CHUCKING REAMERS WITH TAPER SHANK

MM SIZE IS : 5444 - 1978
INCH SIZES BS 328 PART-4 1983
IS : 5445 - 1978
IS : 5446 - 1978
IS : 5447 - 1978

SIZE		PRICE Rs. /PIECE
DIAMETER		HAND REAMER LONG FLUTED MACHINE REAMER CHUCKING REAMER
MM	INCH	
4.00	-	1,314
(4.76)	3/16	1,314
4.50	-	1,314
5.00	-	1,314
(5.56)	7/32	1,314
6.00	-	1,530
(6.35)	1/4	1,530
7.00	-	1,530
(7.14)	9/32	1,530
(7.94)	5/16	1,743
8.00	-	1,743
(8.73)	11/32	1,830
9.00	-	1,830
(9.52)	3/8	1,989
10.00	-	2,205
(10.32)	13/32	2,205
11.00	-	2,470
(11.11)	7/16	2,470
(11.91)	15/32	2,575
12.00	-	2,575
(12.70)	1/2	2,662
13.00	-	3,247
(13.49)	17/32	3,247
14.00	-	3,247
(14.29)	9/16	3,247
15.00	-	3,266
(15.08)	19/32	3,266
(15.87)	5/8	3,266
16.00	-	3,266
(16.67)	21/32	3,771
17.00	-	3,771
(17.46)	11/16	3,771
18.00	-	4,035
(18.26)	23/32	4,282
19.00	-	4,282
(19.05)	3/4	4,282
20.00	-	4,787
(20.64)	13/16	4,880
21.00	-	5,404
22.00	-	5,404
(22.22)	7/8	5,404
23.00	-	6,322
(23.81)	15/16	7,000

SIZE		PRICE Rs. /PIECE
DIAMETER		HAND REAMER LONG FLUTED MACHINE REAMER CHUCKING REAMER
MM	INCH	
24.00	-	7,000
25.00	-	7,020
(25.40)	1	7,152
26.00	-	8,668
(26.99)	1.1/16	9,927
27.00	-	9,927
28.00	-	9,927
(28.57)	1.1/8	9,927
29.00	-	10,525
30.00	-	11,353
(30.16)	1.3/16	11,353
31.00	-	12,535
(31.75)	1.1/4	12,535
32.00	-	12,535
33.00	-	14,244
(33.34)	1.5/16	14,244
34.00	-	15,989
(34.92)	1.3/8	17,491
35.00	-	17,491
36.00	-	17,491
(36.51)	1.7/16	17,637
37.00	-	19,211
38.00	-	19,211
(38.10)	1.1/2	19,211
39.00	-	21,242
(39.69)	1.9/16	23,193
40.00	-	23,193
41.00	-	23,417
(41.27)	1.5/8	23,417
42.00	-	27,579
(42.86)	1.11/16	27,579
43.00	-	27,579
44.00	-	27,579
(44.45)	1.3/4	27,579
45.00	-	32,311
46.00	-	32,311
47.00	-	34,901
(47.62)	1.7/8	37,484
48.00	-	37,484
49.00	-	37,484
(49.21)	1.15/16	37,484
50.00	-	37,484
(50.80)	2	37,484

HSS TAPER PIN REAMERS (TAPER 1 IN 50)

HAND - IS : 5881 -1984

MACHINE - IS : 5918 - 1984

DIA	PRICE Rs. /PIECE	
MM	HAND	MACHINE
6	2,845	2,845
8	3,851	3,851
10	4,258	4,258
12	5,152	5,152
14	5,799	5,799

DIA	PRICE Rs. /PIECE	
MM	HAND	MACHINE
16	6,456	6,456
20	10,042	10,042
25	10,641	10,641
30	14,334	14,334
32	15,723	15,723

DIA	PRICE Rs. /PIECE	
MM	HAND	MACHINE
40	28,147	28,147
50	48,783	48,783
-	-	-
-	-	-
-	-	-

HSS TAPER PIN REAMERS (TAPER 1 IN 48)

HAND/MACHINE - BS 328 (PART 4) 1983

DIA	PRICE Rs. /PIECE	
MM	HAND	MACHINE
1/4	2,647	2,647
9/32	2,894	2,894
5/16	3,216	3,216
11/32	3,621	3,621

DIA	PRICE Rs. /PIECE	
MM	HAND	MACHINE
3/8	3,696	3,696
13/32	4,137	4,137
7/16	4,258	4,258
1/2	4,832	4,832

DIA	PRICE Rs. /PIECE	
MM	HAND	MACHINE
9/16	5,574	5,574
5/8	6,212	6,212
3/4	7,690	7,822
7/8	9,662	9,662

Reamer Terms - General Features

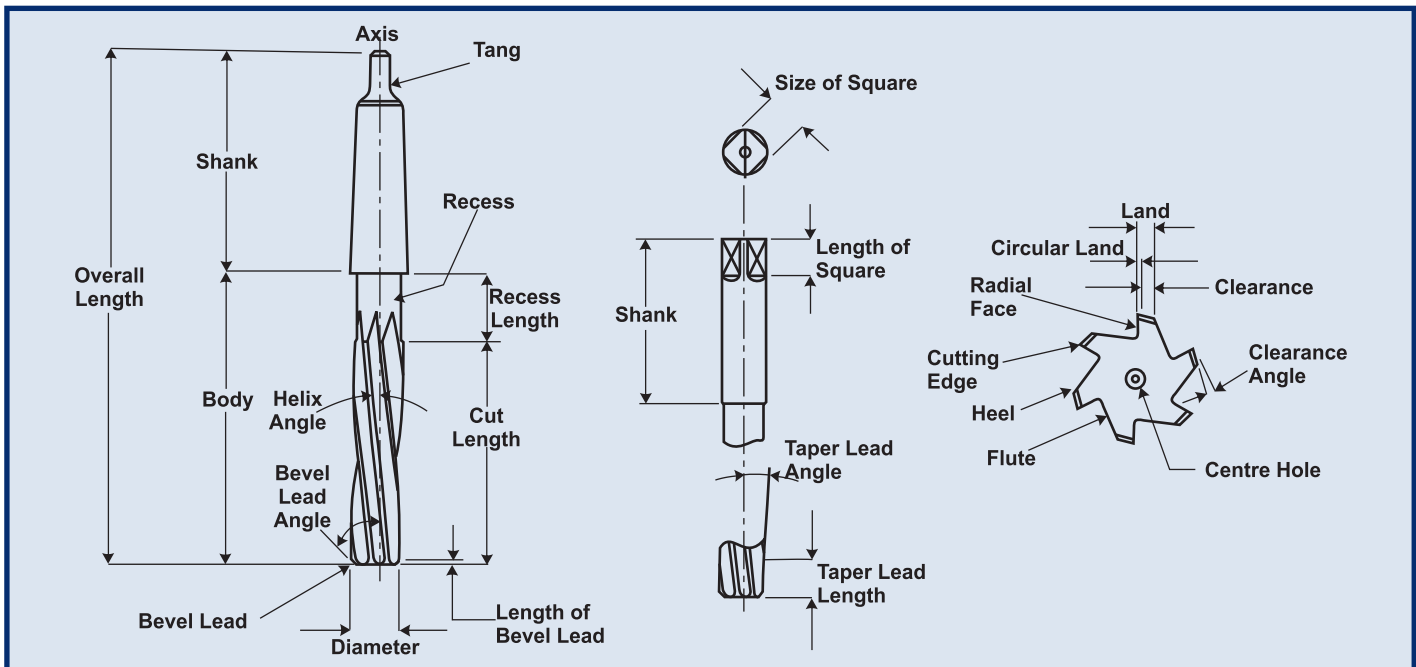

**HIGH SPEED STEEL
TAPER SHANK CORE DRILLS**



Specifications conform to : IS 5366 - 1978, ISO 7079 - 1981
DIN 343 - 1981, BS 328 - 1959
Dimensions in mm / Inch

Size		Price Rs. Piece
mm	inch	
14.00		2,719
14.29	9/16	2,798
15.00		2,919
15.08	19/32	2,919
15.87	5/8	2,948
16.00		2,948
16.67	21/32	3,145
17.00		3,145
17.46	11/16	3,397
18.00		3,652
18.26	23/32	3,652
19.00		4,175
19.05	3/4	4,175
19.84	25/32	4,191
20.00		4,191
20.64	13/16	4,484
21.00		4,484
21.43	27/32	4,739
22.00		4,739
22.22	7/8	5,028
23.00		5,323
23.02	29/32	5,323
23.81	15/16	5,811
24.00		6,072
24.61	31/32	6,072
25.00		7,056
25.40	1	7,056
26.00		7,613
26.19	1.1/32	7,613
26.99	1.1/16	8,404
27.00		8,404
27.78	1.3/32	8,723
28.00		9,241
28.57	1.1/8	9,243
29.00	1.5/32	9,663
29.37		9,663
30.00	1.3/16	10,276
30.16	1.7/32	10,276
30.96		10,665
31.00		11,992

Size		Price Rs. Piece
mm	inch	
31.75	1.1/4	12,516
32.00		13,716
32.54	1.9/32	13,716
33.00		14,000
33.34	1.5/16	14,000
34.00		15,268
34.13	1.11/32	15,268
34.92	1.3/8	16,222
35.00		16,222
35.72	1.13/32	17,447
36.00		17,447
36.51	1.7/16	18,406
37.00		18,406
37.31	1.15/32	18,928
38.00		20,248
38.10	1.1/2	20,248
39.00		22,206
39.69	1.9/16	22,206
40.00		22,206
41.00		24,474
41.27	1.5/8	24,474
42.00		25,201
42.07	1.21/32	25,201
42.86	1.11/16	26,009
43.00		26,009
44.00		27,493
44.45	1.3/4	27,493
45.00		28,464
45.24	1.25/32	28,464
46.00		29,519
46.04	1.13/16	29,519
47.00		30,673
47.62	1.7/8	32,256
48.00		32,256
49.00		34,443
49.21	1.15/16	34,443
50.00		37,064
50.80	2	40,981
51.00		41,337
52.00		45,525

Size		Price Rs. Piece
mm	inch	
52.39	2.1/16	45,525
53.00		53,179
53.97	2.1/8	53,179
54.00		53,179
55.00		55,740
55.56	2.3/16	55,740
56.00		58,101
57.00		58,101
57.15	2.1/4	58,101
58.00		63,492
58.74	2.5/16	63,492
59.00		64,665
60.00		64,665
60.32	2.3/8	64,665
61.00		68,916
61.91	2.7/16	68,916
62.00		68,916
63.00		75,846
63.50	2.1/2	75,846
64.00		82,817
65.00		82,817
65.09	2.9/16	82,817
66.00		86,831
66.67	2.5/8	86,831
67.00		90,456
68.00		94,849
68.26	2.11/16	94,849
69.00		99,482
69.85	2.3/4	1,01,347
70.00		1,01,347
71.00		1,03,355
71.44	2.13/16	1,03,355
72.00		1,08,078
73.00		1,12,085
73.02	2.7/8	1,12,085
74.00		1,16,323
74.61	2.15/16	1,16,323
75.00		1,20,611
76.00		1,26,402
76.20	3	1,26,402

Annular Cutters (HSS & TCT)

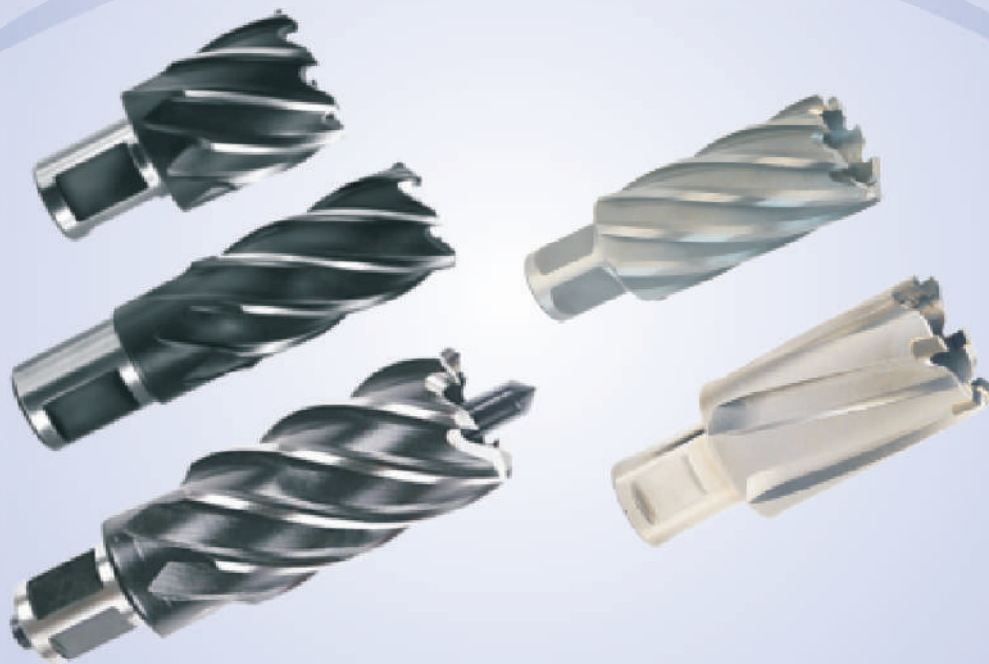

SIZE RANGE :

- Size : 11.0 mm To 60.0 mm
- Depth of Cut : 50.00 mm
- Special size / shank on request
- Coating on request

FEATURE :

- | | | |
|-------------------------------|------|--|
| Reduced Torque and thrust | ———— | Due to peripheral cutting |
| Minimizes kerf area | ———— | Unique center free design |
| Reducing HP and feed pressure | ———— | Alternating tooth geometry |
| Faster feed, less friction | ———— | Evenly distributes chip load to multiple cutting edges |
| Longer tool life | ———— | Special Heat treatment / surface treatment |
| Single pass-cutting, | ———— | No pre drilling required |
| High accuracy | ———— | Less Drifting- Precise Center locating |
| Smooth hole finish | ———— | Evenly distributes chip load to multiple cutting edges |

ANNULAR CUTTER



SIZE DIA. MM	HSS M2 - PRICE RS. / PIECE		HSS M42	TCT
	LENGTH 25 MM	LENGTH 50 MM	LENGTH 50 MM	LENGTH 50 MM
12-13	-	-	-	4,341
14-15	-	-	-	4,341
16*-17	2,134	2682	3,485	4,341
18-19	2,225	2784	3,620	4,341
20*-21	2,339	2897	3,768	4,341
22*-23	2,784	3297	4,286	4,478
24*-25	2,887	3491	4,539	4,478
26*-27	3,058	3686	4,790	5,056
28-29	3,297	4015	5,220	5,056
30*-31	3,457	4217	5,484	5,056
32*-33	3,616	4506	5,859	6,003
34-35	3,810	4804	6,243	6,003
36-37	4,323	5442	7,074	6,828
38-39	4,631	5772	7,505	6,828
40-41	5,077	6321	8,215	6,828
42-43	5,488	6834	8,883	8,338
44-45	6,023	7507	9,759	8,338
46-47	6,480	8066	10,484	8,998
48-49	6,834	8521	11,079	8,998
50-51	7,302	9616	12,501	9,437
52	7,781	9880	12,844	10,109
53	8,020	10199	13,259	10,536
54	8,271	10541	13,703	10,742
55	8,472	10826	14,074	11,004
56	8,772	11156	14,504	11,483
57	9,092	11425	14,853	11,841
58	9,321	11739	15,260	11,991
59	9,606	12001	15,602	12,198
60	9,897	12344	16,046	12,451

EJECTOR PIN

SIZE	TYPE	PRICE RS./ PEICE
6.34 X 73	CL 25	324
6.34 X 98	CL 50	437

HSS TAPS



PRODUCT RANGE

- Types** : Hand & Machine, Straight Flute, Spiral, Spiral Point, Nib, Ring Taps
Range : 2.0 mm to 140.0 mm
Grade of Steel : M2, M35 & M42
Product Standard : ISO 529, IS 6175, BS 949, DIN, ANSI, JIS
Thread Form : Metric, BSW, BSF, BA, BSP, UNF UNC, NPT...

APPLICATIONS

- Steel
- Stainless Steel
- Forged Steel
- Titanium & Nickel Alloy
- Aluminium

INDUSTRIES

- Automotive & Auto components
- Aerospace
- Heavy Engineering
- Power & Energy
- Railways
- Electronics & Electrical

HSS TAPS

HSS GROUND THREAD HAND TAPS - COARSE PITCH										IS 6175 - PART 1,2&3 -1992				
HSS GROUND THREAD MACHINE TAPS - COARSE PITCH										IS 6175 - PART 4 -1991				
HSS GROUND THREAD NUT TAPS - COARSE PITCH										IS 6175 - PART 5 -1992				
Code	Size	Hand & Short Machine Taps									Long Shank Machine Taps			Nut Taps
		IS 6175 Part 1		IS 6175 - Part 2			IS 6175 - Part 3			IS 6175 - Part 4			IS 6175 Part 5	
		WTC_M	WTCPM	WHC_M	WHCPM	WHCTM	WUC_M	WUCPM	WUCTM	WMC_M	WMCPM	WMCTM	WVCNM	
Str. Flute	Spiral Point	Str. Flute	Spiral Point	Spiral Flute	Str. Flute	Spiral Point	Spiral Flute	Type A,C,D	Type B	Spiral	Nut Tap			
Price Each Rs.														
010253A	M1.0 x 0.25	1,164	-	-	-	-	-	-	-	-	-	-	-	
110253A	M1.1 x 0.25	1,164	-	-	-	-	-	-	-	-	-	-	-	
120253A	M1.2 x 0.25	1,164	-	-	-	-	-	-	-	-	-	-	-	
140303A	M1.4 x 0.30	989	-	-	-	-	-	-	-	-	-	-	-	
160353A	M1.6 x 0.35	989	-	-	-	-	-	-	-	-	-	-	-	
180353A	M1.8 x 0.35	989	-	-	-	-	-	-	-	-	-	-	-	
020403A	M2.0 x 0.40	711	830	-	-	-	-	-	-	-	-	-	-	
220453A	M2.2 x 0.45	711	830	-	-	-	-	-	-	-	-	-	-	
230453A	M2.3 x 0.40	711	830	-	-	-	-	-	-	-	-	-	-	
250453A	M2.5 x 0.45	711	-	-	-	-	-	-	-	-	-	-	-	
260453A	M2.6 x 0.45	711	830	-	-	-	-	-	-	-	-	-	-	
030503A	M3.0 x 0.50	-	-	428	536	584	-	-	-	942	1,111	781	-	
350603A	M3.5 x 0.60	-	-	428	536	584	-	-	-	942	1,111	781	-	
040703A	M4.0 x 0.70	-	-	428	536	584	-	-	-	942	1,111	781	-	
450753A	M4.5 x 0.75	-	-	457	566	613	-	-	-	692	824	830	-	
050803A	M5.0 x 0.80	-	-	457	566	613	-	-	-	673	824	830	-	
061003A	M6.0 x 1.00	-	-	457	566	624	-	-	-	721	879	907	942	
081253A	M8.0 x 1.25	-	-	550	655	691	-	-	-	785	958	-	1066	
101503A	M10 x 1.50	-	-	662	818	869	-	-	-	1,006	1,204	-	1416	
121753A	M12 x 1.75	-	-	-	-	-	1,039	1,254	1,382	1,428	1,691	-	2176	
142003A	M14 x 2.00	-	-	-	-	-	1,516	1,833	2,099	2,076	2,457	-	3013	
162003A	M16 x 2.00	-	-	-	-	-	1,516	1,833	2,099	2,076	2,457	2,699	3013	
182503A	M18 x 2.50	-	-	-	-	-	2,293	2,751	3,056	3,046	3,590	3,871	4603	
202503A	M20 x 2.50	-	-	-	-	-	2,929	3,509	4,076	3,751	4,412	4,612	6160	
222503A	M22 x 2.50	-	-	-	-	-	3,137	3,761	4,224	4,194	4,944	-	6240	
243003A	M24 x 3.00	-	-	-	-	-	3,493	4,198	4,589	4,547	5,364	5,826	7083	
253003A	M25 x 3.00	-	-	-	-	-	4,267	5,554	-	5,703	-	-	8472	
273003A	M27 x 3.00	-	-	-	-	-	5,298	6,356	6,849	6,548	-	-	10879	
303503A	M30 x 3.50	-	-	-	-	-	5,925	7,116	7,655	7,526	-	-	13709	
333503A	M33 x 3.50	-	-	-	-	-	7,221	9,349	10,314	8,837	-	-	15119	
364003A	M36 x 4.00	-	-	-	-	-	10,050	12,060	13,002	12,515	-	-	19576	
394003A	M39 x 4.00	-	-	-	-	-	11,810	14,155	-	13,906	-	-	23325	
424503A	M42 x 4.50	-	-	-	-	-	13,758	16,503	-	17,938	-	-	27784	
454503A	M45 x 4.50	-	-	-	-	-	18,529	22,234	-	21,277	-	-	33510	
485003A	M48 x 5.00	-	-	-	-	-	19,761	23,712	-	23,956	-	-	38985	
525003A	M52 x 5.00	-	-	-	-	-	24,806	29,761	-	27,722	-	-	-	
565503A	M56 x 5.50	-	-	-	-	-	35,302	42,356	-	38,816	-	-	-	
605503A	M60 x 5.50	-	-	-	-	-	37,208	44,643	-	42,097	-	-	-	
646003A	M64 x 6.00	-	-	-	-	-	39,137	46,967	-	47,513	-	-	-	
686003A	M68 x 6.00	-	-	-	-	-	-	58,585	-	66,200	-	-	-	
726003A	M72 x 6.00	-	-	-	-	-	65,529	-	-	-	-	-	-	
766003A	M76 x 6.00	-	-	-	-	-	80,142	-	-	-	-	-	-	
806003A	M80 x 6.00	-	-	-	-	-	96,804	-	-	-	-	-	-	
856003A	M85 x 6.00	-	-	-	-	-	1,19,551	-	-	-	-	-	-	
906003A	M90 x 6.00	-	-	-	-	-	1,49,210	-	-	-	-	-	-	
956003A	M95 x 6.00	-	-	-	-	-	1,87,863	-	-	-	-	-	-	
100603A	M100 x 6.00	-	-	-	-	-	2,32,141	-	-	-	-	-	-	

- The tap sizes up to M6 will be supplied with male centers on both sides Above M6 taps will be supplied with female centers on both sides.
- Please contact local sales team for prices of serial Taps, M35 & M42 Taps, Left Hand Taps

HSS TAPS

HSS GROUND THREAD HAND TAPS - FINE PITCH											IS 6175 - PART 1,2&3 -1992
HSS GROUND THREAD MACHINE TAPS - FINE PITCH											IS 6175 - PART 4 -1991
HSS GROUND THREAD NUT TAPS - FINE PITCH											IS 6175 - PART 5 -1992
Hand & Short Machine Taps									Long Shank Machine Taps		Nut Taps
Code	Size	IS 6175 Part 1	IS 6175 - Part 2			IS 6175 - Part 3			IS 6175 - Part 4		IS 6175 Part 5
		WTF_M	WHF_M	WHFPM	WHFTM	WUF_M	WUFPM	WUFTM	WMF_M	WMF_M	WVFNM
		Str. Flute	Str. Flute	Spiral Point	Spiral Flute	Str. Flute	Spiral Point	Spiral Flute	Type A,C,D	Type B	Nut Tap
Price Each Rs.											
010023A	M1.0 x 0.20	1222	-	-	-	-	-	-	-	-	-
110203A	M1.1 x 0.20	1222	-	-	-	-	-	-	-	-	-
140203A	M1.4 x 0.20	1110	-	-	-	-	-	-	-	-	-
160203A	M1.6 x 0.20	1110	-	-	-	-	-	-	-	-	-
180203A	M1.8 x 0.20	1110	-	-	-	-	-	-	-	-	-
020253A	M2.0 x 0.25	939	-	-	-	-	-	-	-	-	-
222503A	M2.2 x 0.25	939	-	-	-	-	-	-	-	-	-
250303A	M2.5 x 0.30	939	-	-	-	-	-	-	-	-	-
260303A	M2.6 x 0.30	939	-	-	-	-	-	-	-	-	-
030353A	M3.0 x 0.35		615	765	828	638	730	815	813	1,034	-
350353A	M3.5 x 0.35		615	765	828	638	730	815	866	963	-
040503A	M4.0 x 0.50		638	765	775	638	730	815	813	924	-
0450503A	M4.5 x 0.50		595	736	799	647	749	815	1,284	1,436	-
050503A	M5.0 x 0.50		625	745	828	651	749	815	822	963	-
060753A	M6.0 x 0.75		625	745	792	651	786	815	822	963	1,110
070753A	M7.0 x 0.75		719	-	965	743	896	928	942	1,110	1,362
080753A	M8.0 x 0.75		719	-	965	743	896	928	942	1,110	1,240
081003A	M8.0 x 1.00		651	781	842	719	811	928	869	1,030	1,240
091003A	M9.0 x 1.00		806	1,027	1001	799	922	1,048	1,116	1,315	1,240
101003A	M10 x 1.00		732	898			922	1,048	1,086	1,211	1,627
101253A	M10 x 1.25		732	898		799	922	1,048	1,086	1,225	1,627
121003A	M12 x 1.00					1,222	1,383	1,631	1,565	1,840	2,547
121253A	M12 x 1.25					1,222	1,383	1,564	1,565	1,840	2,547
121503A	M12 x 1.50					1,222	1,383		1,565	1,840	2,547
141003A	M14 x 1.00					1,571	1,883	2,239	2,019	2,391	3,799
141253A	M14 x 1.25					1,604	1,934	2,192	2,060	2,432	3,799
141503A	M14 x 1.50					1,522	1,869	2,089	1,936	2,287	3,799
161003A	M16 x 1.00					1,568	1,931	2,192	2,175	2,570	3,799
161503A	M16 x 1.50					1,523	1,869	2,089	1,936	2,457	3,799
181003A	M18 x 1.00					2,863	3,199	3,409	3,553	4,191	5,377
181503A	M18 x 1.50					2,612	2,921	3,409	3,259	4,146	5,377
182003A	M18 x 2.00					2,863	3,199	3,409	3,553	4,191	5,377
201503A	M20 x 1.50					3,304	3,688		4,254	5,024	6,899
202003A	M20 x 2.00					3,289	4,254	4,352	4,686	5,946	6,899
221503A	M22 x 1.50						4,021	4,676	4,414	5,214	7,325
222003A	M22 x 2.00					3,877	4,665	4,676	4,758	6,030	7,325
241503A	M24 x 1.50					3,944	4,400	5,176	4,927	5,815	8,705
242003A	M24 x 2.00					3,937	5,070	5,176	5,192	6,587	8,705
251503A	M25 x 1.50					4,221	5,394	-	6,282	7,442	9,787
252003A	M25 x 2.00					4,179	5,394	-	6,282	7,442	-
261503A	M26 x 1.50					4,400	5,513	-	6,458	7,622	-
262003A	M26 x 2.00					4,400	5,513	-	6,458	7,622	-
271503A	M27 x 1.50					5,878	7,092	-	7,744	9,418	-
272003A	M27 x 2.00					5,878	7,092	-	7,744	9,418	-
281503A	M28 x 1.50					5,898	7,376	-	8,346	11,463	-
282003A	M28 x 2.00					5,898	7,376	-	8,346	11,463	-
301503A	M30 x 1.50					6,617	7,954	-	8,708	11,292	-
302003A	M30 x 2.00					6,617	7,963	-	8,708	11,292	-
303003A	M30 x 3.00					6,630	7,963	-	8,708	11,292	-
321503A	M32 x 1.50					7,048	8,729	-	9,617	12,442	-
322003A	M32 x 2.00					7,048	8,729	-	9,617	12,442	-

HSS TAPS

Hand & Short Machine Taps						Long Shank Machine Taps			Nut Taps		
Code	Size	IS 6175 Part 1	IS 6175 - Part 2		IS 6175 - Part 3			IS 6175 - Part 4		IS 6175 Part 5	
		WTF_M	WHF_M	WHFPM	WHFTM	WUF_M	WUFPM	WUFTM	WMF_M	WMF_M	WVFNM
		Str. Flute	Str. Flute	Spiral Point	Spiral Flute	Str. Flute	Spiral Point	Spiral Flute	Type A,C,D	Type B	Nut Tap
Price Each Rs.											
331503A	M33 x 1.50	-	-	-	-	8,088	10,116	-	10,529	13,128	-
332003A	M33 x 2.00	-	-	-	-	8,088	10,116	-	10,529	13,128	-
333003A	M33 x 3.00	-	-	-	-	8,088	10,116	-	10,529	13,128	-
351503A	M35 x 1.50	-	-	-	-	11,239	13,991	-	14,501	18,271	-
361503A	M36 x 1.50	-	-	-	-	11,235	13,991	-	14,501	18,271	-
362003A	M36 x 2.00	-	-	-	-	11,235	13,991	-	14,501	18,271	-
363003A	M36 x 3.00	-	-	-	-	11,220	13,991	-	14,501	18,271	-
391503A	M39 x 1.50	-	-	-	-	14,000	-	-	-	-	-
392003A	M39 x 2.00	-	-	-	-	14,000	-	-	-	-	-
393003A	M39 x 3.00	-	-	-	-	14,000	-	-	-	-	-
421503A	M42 x 1.50	-	-	-	-	15,561	-	-	-	-	-
422003A	M42 x 2.00	-	-	-	-	15,561	-	-	-	-	-
423003A	M42 x 3.00	-	-	-	-	15,561	-	-	-	-	-
424003A	M42 x 4.00	-	-	-	-	15,561	-	-	-	-	-
451503A	M45 x 1.50	-	-	-	-	21,571	-	-	-	-	-
452003A	M45 x 2.00	-	-	-	-	21,571	-	-	-	-	-
453003A	M45 x 3.00	-	-	-	-	21,571	-	-	-	-	-
454003A	M45 x 4.00	-	-	-	-	21,571	-	-	-	-	-
481503A	M48 x 1.50	-	-	-	-	20,957	-	-	-	-	-
482003A	M48 x 2.00	-	-	-	-	20,957	-	-	-	-	-
483003A	M48 x 3.00	-	-	-	-	20,957	-	-	-	-	-
484003A	M48 x 4.00	-	-	-	-	20,957	-	-	-	-	-
501503A	M50 x 1.50	-	-	-	-	24,778	-	-	-	-	-
502003A	M50 x 2.00	-	-	-	-	24,778	-	-	-	-	-
503003A	M50 x 3.00	-	-	-	-	24,778	-	-	-	-	-
521503A	M52 x 1.50	-	-	-	-	27,928	-	-	-	-	-
522003A	M52 x 2.00	-	-	-	-	27,928	-	-	-	-	-
523003A	M52 x 3.00	-	-	-	-	27,928	-	-	-	-	-
524003A	M52 x 4.00	-	-	-	-	27,928	-	-	-	-	-
561503A	M56 x 1.50	-	-	-	-	36,439	-	-	-	-	-
562003A	M56 x 2.00	-	-	-	-	36,439	-	-	-	-	-
563003A	M56 x 3.00	-	-	-	-	36,439	-	-	-	-	-
564003A	M56 x 4.00	-	-	-	-	36,439	-	-	-	-	-
601503A	M60 x 1.50	-	-	-	-	40,656	-	-	-	-	-
602003A	M60 x 2.00	-	-	-	-	40,656	-	-	-	-	-
603003A	M60 x 3.00	-	-	-	-	41,574	-	-	-	-	-
604003A	M60 x 4.00	-	-	-	-	41,574	-	-	-	-	-
641503A	M64 x 1.50	-	-	-	-	43,316	-	-	-	-	-
642003A	M64 x 2.00	-	-	-	-	43,316	-	-	-	-	-
643003A	M64 x 3.00	-	-	-	-	44,096	-	-	-	-	-
644003A	M64 x 4.00	-	-	-	-	44,096	-	-	-	-	-
681503A	M68 x 1.50	-	-	-	-	54,849	-	-	-	-	-
682003A	M68 x 2.00	-	-	-	-	54,849	-	-	-	-	-
683003A	M68 x 3.00	-	-	-	-	40,835	-	-	-	-	-
684003A	M68 x 4.00	-	-	-	-	55,550	-	-	-	-	-
724003A	M72 x 4.00	-	-	-	-	61,156	-	-	-	-	-

- The tap sizes up to M6 will be supplied with male centers on both sides Above M6 taps will be supplied with female centers on both sides.
- Please contact local sales team for MOQ for all fine pitch taps and for prices of Serial Taps, M35 & M42 Taps, Left Hand Taps

HSS HAND TAPS - BSW(WTK_) & BSF (WTL_)			BS949 (Part 1) - 1992			
Part Code		Size	Straight Flute	Spiral Point	Spiral flute	Nut taps
BSW(WTK_)	BSF(WTL_)					
I018406A*	-	1/8"	446	536	631	-
I316246A*	I316326A	3/16"	446	560	603	-
I014206A*	I014266A	1/4"	467	560	665	976
I516186A*	I516226A	5/16"	523	657	698	1,064
I038166A*	I038206A	3/8"	638	786	859	1,292
I716146A*	I716186A	7/16"	822	1,018	1,137	1,742
I012126A*	I012166A	1/2"	1,045	1,254	1,379	2,168
I916126A	I916166A	9/16"	1,522	1,833	2,121	3,013
I058116A*	I058146A	5/8"	1,522	1,833	2,121	3,013
I116116A	I116146A	11/16"	2,223	2,742	2,994	3,874
I034106A*	I034126A	3/4"	2,311	2,782	3,078	4,612
I078096A	I078116A	7/8"	3,194	3,826	4,224	6,236
I100086A*	I100106A	1"	4,003	4,809	5,080	8,127
I118076A	I118096A	1.1/8"	5,377	6,452	-	10,944
I114076A*	I114096A	1.1/4"	6,483	7,780	-	16,277
I138066A	I138086A	1.3/8"	8,362	10,034	-	19,526
I112066A	I112086A	1.1/2"	10,050	12,051	-	-

HSS HAND TAPS - UNC(WTG_) & UNF(WTJ_)			BS949 (Part 1) - 1992			
Part Code		Size	Straight Flute	Spiral Point	Spiral flute	Nut taps
UNC(WTG_)	UNF(WTJ_)					
-	N000806A	No 0	1,045	-	-	-
N001646A	N001726A	No 1	1,045	-	-	-
N002566A	N002646A	No 2	736	-	-	-
N004406A	N004486A	No 4	501	-	-	-
N005406A	N005446A	No 5	501	604	603	-
N006326A	N006406A	No 6	501	604	603	-
N008326A	N008366A	No 8	501	604	603	-
N010246A	N010326A	No 10	501	604	603	-
N012246A	N012286A	No 12	618	736	647	-
I018286A	I018406A	1/8"	446	536	631	-
I316246A	I316326A	3/16"	446	560	603	-
I014206A*	I014286A	1/4"	463	569	665	974
I516186A*	I516246A	5/16"	524	657	699	1,064
I038166A*	I038246A	3/8"	638	786	859	1,292
I716146A	I716206A	7/16"	822	1,018	1,137	1,739
I012136A*	I012206A	1/2"	1,045	1,254	1,379	2,171
I916126A	I916186A	9/16"	1,522	1,833	2,122	3,013
I058116A*	I058186A*	5/8"	1,522	1,833	2,122	3,013
I116116A	I116116A	11/16"	2,223	2,741	2,996	3,872
I034106A*	I034166A	3/4"	2,311	2,782	3,078	4,611
I078096A	I078146A	7/8"	3,194	3,826	4,224	6,236
I100086A*	I100126A*	1"	4,003	4,809	5,080	8,127
I118076A	I118126A	1.1/8"	5,377	6,449	-	10,944
I114076A	I114126A	1.1/4"	6,481	7,776	-	16,276
I138066A	I138126A	1.3/8"	8,362	10,035	-	19,526
I112066A	I112126A	1.1/2"	10,050	12,049	-	-

- The tap sizes up to M6 will be supplied with male centers an both sides Above M6 taps will be supplied with female centers on both sides.
- Please contact local sales team for MOQ of above Taps & for prices of Serial Taps, M35 & M42 Taps, Left Hand Taps

HSS HAND TAPS - BSCy (Code : WHQ_)				BS949 (Part II) - 1951		
Code	Size	Straight flute	Code	Size	Straight flute	
Price Each Rs.						
N11SWG6A	14 Swg	811	I516306A	5/16"	692	
N10SWG6A	10 Swg	430	I716266A	7/16"	1,044	
N09SWG6A	9 Swg	430	I012266A	1/2"	1,305	
I532326A	5/32"	504	I916206A	9/16"	2,070	
I316326A	3/16"	504	I100246A	1"	4,104	
I732266A	7/32"	540	O167096A	1.370"	8,644	
I014266A	1/4"	569	O137596A	1.375"	8,644	

- The manufacturing range of BSCy taps is 14 Swg upwards.

HSS HAND TAPS - BA (Code : WTM_)				BS949 (Part 1) - 1992			
Code	Size	Straight flute	Spiral point	Code	Size	Straight flute	Spiral point
Price Each Rs.							
N0BA106A	No. 0	551	660	N8BA436A	No. 8	902	869
N1BA906A	No. 1	551	660	10BA356A	No. 10	1,077	1,252
N2BA816A	No. 2	487	596	11BA316A	No. 11	1,670	2,006
N3BA736A	No. 3	487	596	12BA286A	No. 12	1,670	2,006
N4BA666A	No. 4	487	596	13BA256A	No. 13	1,752	-
N5BA596A	No. 5	487	596	14BA236A	No. 14	1,752	-
N6BA536A	No. 6	536	596	-	-	-	-

- All the tap sizes will be supplied with male centers on both sides.

HSS PIPE TAPS				BS949 (Part II) - 1969			
Parallel Thread				Taper Thread			
Code	Size	WHP_	NPS	WHU_	WHR_	WHS_	WHT_
		BSP		NPSF	BSPT	NPT	NPTF
Price Each Rs.							
I018286A	1/8"	689	813	979	1,005	1,030	1,080
I014196A	1/4"	1,073	1,410	1,720	1,752	1,802	2,031
I038196A	3/8"	1,613	1,808	2,182	2,251	2,289	2,648
I012146A	1/2"	2,354	2,630	3,161	3,370	3,443	3,871
I058146A	5/8"	2,670	-	-	-	-	-
I034146A	3/4"	3,517	3,871	4,624	4,996	5,100	5,709
I078146A	7/8"	4,465	-	-	-	-	-
I001116A	1"	5,547	6,537	7,822	7,768	7,964	8,895
I114116A	1.1/4"	8,555	10,105	12,125	11,118	11,372	13,111
I112116A	1.1/2"	10,695	12,603	15,116	13,600	14,109	-
I134116A	1.3/4"	13,376	15,719	18,855	-	-	-
I200116A	2"	19,520	22,525	27,029	24,903	25,500	-
I214116A	2.1/4"	33,298	-	-	-	-	-
I212116A	2.1/2"	47,509	-	-	72,623	72,623	-
I234116A	2.3/4"	53,413	-	-	-	-	-
I300116A	3"	60,201	-	-	94,516	94,516	-
I312116A	3.1/2"	79,117	-	-	1,26,196	1,26,196	-
I400116A	4"	99,566	-	-	1,59,224	1,59,224	-

- Minimum order value of Rs.20000/- Nett.

HSS NIB TAPS TO OUR STANDARD - (Code : XNC_)					Price Each Rs.		
	Size	Straight flute		Code	Size	Straight flute	
		M35	GV 3			M35	GV3
M030503D	M3 x 0.5	775	933	M081253D	M8 x1.25	1,008	1,226
M040703D	M4 x 0.7	791	958	M101503D	M10 x1.5	1,276	1,508
M050803D	M5 x 0.8	839	990	M121753D	M12 x1.75	1,499	1,718
M061003D	M6 x 1.0	932	990	-	-	-	-

- The above taps will be supplied with TiCN / TiAlN Coating
- The tap sizes upto M6" will be supplied with malecenters on both sides, above M6 taps will be supplied with female centers on both sides
- The tap sizes up to M6 will be supplied with 3 flutes, above M6 will be supplied with 5 flute. Any other style of Nib taps can be offered on specific request.
- **Minimum order value of Rs.20000/- Nett.**
- The manufacturing range of Nib taps is M3 upwards , for the sizes above M12, quotation will be given on Specific request

UN TAPS (WTV_)				BS949 (Part1) -1992	
Part Code	Size	Price Each Rs.	Part Code	Size	Price Each Rs.
I118086A	1.1/8" X 8	5,377	I134086A	1.3/4" X 8	13,750
I114086A	1.1/4" X 8	6,481	I178086A	1.7/8" X 8	16,619
I138086A	1.3/8" X 8	8,362	I200086A	2" X 8	21,672
I112086A	1.1/2" X 8	10,050	I214086A	2.1/4" X 8	29,854
I158086A	1.5/8" X 8	11,751	I212086A	2.1/2" X 8	37,946

HSS GROUND THREAD HAND TAPS-COARSE PITCH - HELICOIL (WHR_)				IS 6175 : 1992	
Part Code	Size	Price Each Rs.	Part Code	Size	Price Each Rs.
M030503A	M3 X 0.50	428	M142003A	M14 X 2.00	2,293
M040704A	M4 X 0.70	454	M162003A	M16 X 2.00	
M050805A	M5 X 0.80	545	M182503A	M18 X 2.50	2,929
M061006A	M6 X 1.00	545	M202503A	M20 X 2.50	3,137
M081253A	M8 X 1.25	662	M222503A	M22 X 2.50	3,493
M101503A	M10X 1.50	1,039	M243003A	M24 X 3.00	5,298
M121753A	M12X 1.75	1,516	M273003A	M27 X 3.00	5,925
		-	M303503A	M30 X 3.50	6,926

- Taps with different coatings can be provided with additional cost at actuals.
- Taps for various application like cast iron, Aluminium, Brass etc. can be supplied on demand.
- Taps of DIN 371, DIN 374, DIN 376, DIN 2184, JIS 4430 1998, ISO 529 1993 can be supplied on demand.

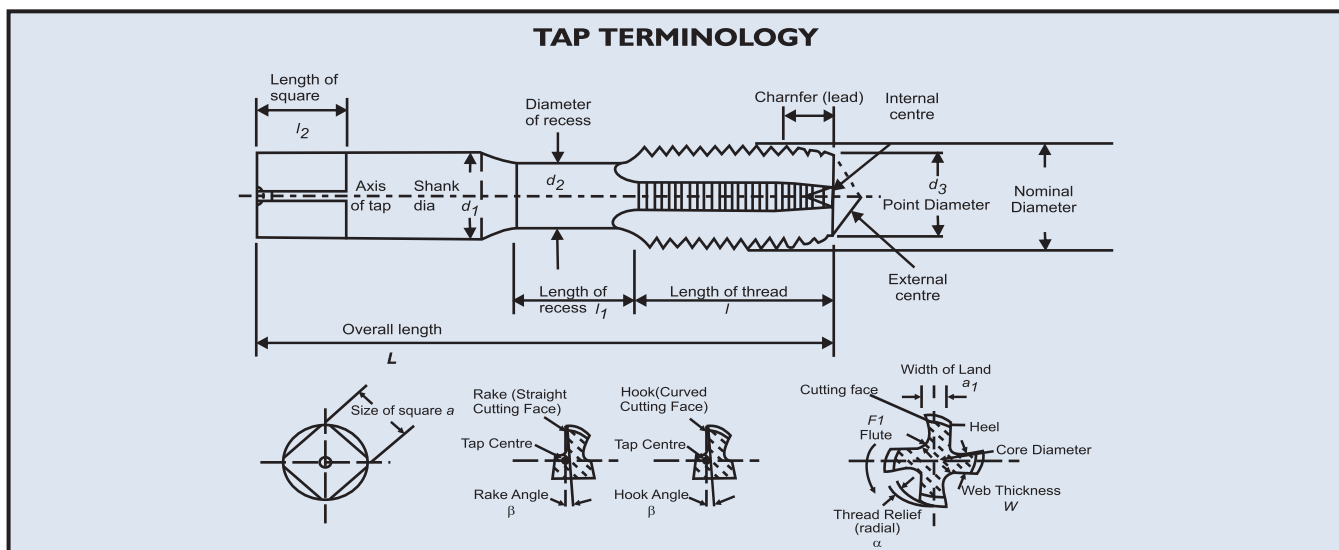



**MIRANDA
EDGE**

**HIGH
PERFORMANCE
PLATINUM
CUT TAPS**



MIRANDA EDGE - PLATINUM CUT TAPS PRICE - Rs. / Each									
Size	SPPT			SPIREX			BOT		
	UNCOATED	TIN	TIALN	UNCOATED	TIN	TIALN	UNCOATED	TIN	TIALN
	MA1	MA2	MA3	MB1	MB2	MB3	MC1	MC2	MC3
M3 x 0.5	753	866	905	865	992	1,036	627	721	754
M4 x 0.7	753	866	905	865	992	1,036	627	721	754
M5 x 0.8	788	907	948	905	1,039	1,085	660	759	792
M6 x 1.0	788	907	948	905	1,039	1,085	660	759	792
M8 x 1.0	-	-	-	1,124	1,292	1,348	-	-	-
M8 x 1.25	886	1,017	1,063	1,014	1,164	1,215	740	849	887
M10 x 1.0	1,272	1,463	1,527	1,457	1,676	1,748	-	-	-
M10 x 1.25	1,272	1,463	1,527	1,457	1,676	1,748	1,062	1,222	1,276
M10 x 1.5	1,094	1,258	1,314	1,254	1,443	1,506	914	1,052	1,098
M12 x 1.0	1,969	2,262	2,363	2,253	2,593	2,704	-	-	-
M12 x 1.25	1,969	2,262	2,363	2,253	2,593	2,704	1,639	1,883	1,966
M12 x 1.50	1,969	2,262	2,363	2,253	2,593	2,704	1,639	1,883	1,966
M12 x 1.75	1,689	1,941	2,025	1,933	2,224	2,320	1,408	1,618	1,690

High Performance Platinum Cut Taps

Type	picture	Range	Series	Thread form	Blank Standard	Treatment	Material	Tapping type	Application
Straight Flute		M3-M12	MC 1	M	IS -6175/ISO 529	Bright	HSS-E	Blind/ Through	Medium to high tensile steel , Alloy steel , MS , general application
			MC2	M	IS -6175/ISO 529	TiN			
			MC3	M	IS -6175/ISO 529	TiAlN			
Straight Flute for cast Iron		M3-M12	CI MC 1	M	IS -6175/ISO 529	Bright	HSS-E	Blind/ Through	cast iron , SG iron , abrasive type steel
			CI MC 2	M	IS -6175/ISO 529	TiN			
			CI MC 3	M	IS -6175/ISO 529	TiAlN			
Spiral Point		M3-M12	MA 1	M	IS -6175/ISO 529	Bright	HSS-E	Through holes	Medium to high tensile steel , Alloy steel , MS , general application
			MA 2	M	IS -6175/ISO 529	TiN			
			MA3	M	IS -6175/ISO 529	TiAlN			
Spiral Flute		M3-M12	MB 1	M	IS -6175/ISO 529	Bright	HSS-E	Blind Holes	Medium to high tensile steel , Alloy steel , MS , general application
			MB2	M	IS -6175/ISO 529	TiN			
			MB3	M	IS -6175/ISO 529	TiAlN			

Recommended Parameter

Material	RC Value	HB value	Recommended Mtr / min	
			HSS-E	
			Uncoated	Coated
Structural steels, free-cutting steels Case hardened steels, heat-treatable steels	<20	<236	9-15	12-20
	<25	<256	9-13	11-18
	<30	<286	6-9	9-16
	<35	<326	5-8	6-10
	<38	<386	4-8	6-12
Stainless- and acid-resistant steels, sulphured austenitic martensitic		<186	8-13	12-16
	<25	<256	6-9	9-12
	<36	<286	6-9	7-12
Alloyed case hardened steels Alloyed heat-treatable steels Alloyed tool steels High speed tool steels	<35	<326	3-6	6-9
	<25	<256	3-6	9-12
	<36	<286	8-10	9-15
	<38	<386	3-5	4-9
Cast iron Spheroidal graphite iron Malleable cast iron		<186	15-20	18-25
	<25	<256	9-12	14-18
	<35	<326	5-10	6-12
Brass			9-13	-
			9-15	-

TUNGSTEN CARBIDE TIPPED TOOLS







ISO 1 (110) BAR TURNING TOOLS	SHANK SIZE H X B (mm)	L (mm)	RIGHT HAND (RH)		LEFT HAND (LH)		PRICE RS. / PIECE
			ORDER CODE - MIR100				
			P30	K20	P30	K20	
	1010	90	1004RC	1001RC	1004LC	1001LC	416
	1212	100	1014RC	1011RC	1014LC	1011LC	452
	1616	110	1034RC	1031RC	1034LC	1031LC	610
	2020	125	1054RC	1051RC	1054LC	1051LC	973
	2525	140	1074RC	1071RC	1074LC	1071LC	1460
	3232	170	1094RC	1091RC	1094LC	1091LC	2382
	4040	200	1114RC	1111RC	1114LC	1111LC	4907
	5050	240	1134RC	1131RC	1134LC	1131LC	10037
	1610	110	1024RC	1021RC	1024LC	1021LC	487
	2012	125	1044RC	1041RC	1044LC	1041LC	672
	2516	140	1064RC	1061RC	1064LC	1061LC	902
	3220	170	1084RC	1081RC	1084LC	1081LC	1538
	4025	200	1104RC	1101RC	1104LC	1101LC	2473
	5032	240	1124RC	1121RC	1124LC	1121LC	5638
	6040	280	1144RC	1141RC	1144LC	1141LC	10256
ISO 2 (111) CRANKED TURNING & FACING TOOLS	1010	90	1204RC	1201RC	1204LC	1201LC	452
	1212	100	1214RC	1211RC	1214LC	1211LC	497
	1616	110	1234RC	1231RC	1234LC	1231LC	688
	2020	125	1254RC	1251RC	1254LC	1251LC	953
	2525	140	1274RC	1271RC	1274LC	1271LC	1432
	3232	170	1294RC	1291RC	1294LC	1291LC	2465
	4040	200	1314RC	1311RC	1314LC	1311LC	4800
	5050	240	1334RC	1331RC	1334LC	1331LC	10185
	1610	110	1224RC	1221RC	1224LC	1221LC	536
	2012	125	1244RC	1241RC	1244LC	1241LC	725
	2516	140	1264RC	1261RC	1264LC	1261LC	973
	3220	170	1284RC	1281RC	1284LC	1281LC	1548
	4025	200	1304RC	1301RC	1304LC	1301LC	2771
	5032	240	1324RC	1321RC	1324LC	1321LC	5751
	6040	280	1344RC	1341RC	1344LC	1341LC	10441
ISO 3 (123) CRANKED FINISHING TOOLS	1010	90	2204RC	2201RC	2204LC	2201LC	452
	1212	100	2214RC	2211RC	2214LC	2211LC	497
	1616	110	2234RC	2231RC	2234LC	2231LC	688
	2020	125	2254RC	2251RC	2254LC	2251LC	953
	2525	140	2274RC	2271RC	2274LC	2271LC	1432
	3232	170	2294RC	2291RC	2294LC	2291LC	2465
	4040	200	2314RC	2311RC	2314LC	2311LC	4800
	5050	240	2334RC	2331RC	2334LC	2331LC	10185
	1610	110	2224RC	2221RC	2224LC	2221LC	536
	2012	125	2244RC	2241RC	2244LC	2241LC	725

ISO 3 (123) CRANKED FINISHING TOOLS	SHANK SIZE H X B (mm)	L (mm)	RIGHT HAND (RH)		LEFT HAND (LH)		PRICE RS./ PIECE	
			ORDER CODE - MIR100					
			P30	K20	P30	K20		
	2516	140	2264RC	2261RC	2264LC	2261LC	974	
	3220	170	2284RC	2281RC	2284LC	2281LC	1,548	
	4025	200	2304RC	2301RC	2304LC	2301LC	2,771	
	5032	240	2324RC	2321RC	2324LC	2321LC	5,751	
	6040	280	2344RC	2341RC	2344LC	2341LC	10,441	
ISO 4 (127) RECESSING TOOLS	NEUTRAL (NH)							
		1010	90	2604SC	2601SC			452
		1212	100	2614SC	2611SC			557
		1616	110	2634SC	2631SC			828
		2020	125	2654SC	2651SC			1,244
		2525	140	2674SC	2671SC			2,029
		3232	170	2694SC	2691SC			4,004
		4040	200	2714SC	2711SC			9,897
		5050	240	2076SC	2731SC			17,771
		1610	110	2624SC	2621SC			610
		2012	125	2644SC	2641SC			652
		2516	140	2664SC	2661SC			960
		3220	170	2684SC	2681SC			1,851
		4025	200	2704SC	2701SC			3,216
	5032	240	2724SC	2721SC			6,114	
ISO 5 (126) CRANKED FACING TOOLS			RIGHT HAND (RH)		LEFT HAND (LH)			
		1010	90	2404RC	2401RC	2404LC	2401LC	452
		1212	100	2414RC	2411RC	2414LC	2411LC	497
		1616	110	2434RC	2430RC	2434LC	2431LC	688
		2020	125	2454RC	2451RC	2454LC	2451LC	953
		2525	140	2474RC	2471RC	2474LC	2471LC	1,432
		3232	170	2494RC	2491RC	2494LC	2491LC	2,466
		4040	200	2426RC	2511RC	2426LC	2511LC	4,800
		5050	240	2428RC	2531RC	2428LC	2531LC	10,185
		1610	110	2424RC	2421RC	2424LC	2421LC	536
		2012	125	2444RC	2441RC	2444LC	2441LC	726
		2516	140	2464RC	2461RC	2464LC	2461LC	974
		3220	170	2484RC	2481RC	2484LC	2481LC	1,548
		4025	200	2504RC	2501RC	2504LC	2501LC	2,774
	5032	240	2524RC	2521RC	2524LC	2521LC	5,751	
ISO 6 (117) CRANKED KNIFE TOOLS		1010	90	2004RC	2001RC	2004LC	2001LC	452
		1212	100	2014RC	2011RC	2014LC	2011LC	497
		1616	110	2034RC	2031RC	2034LC	2031LC	688
		2020	125	2054RC	2051RC	2054LC	2051LC	953
		2525	140	2074RC	2071RC	2074LC	2071LC	1,432
		3232	170	2094RC	2091RC	2094LC	2091LC	2,466
	4040	200	2114RC	2111RC	2114LC	2111LC	4,800	

ISO 6 (117) CRANKED KNIFE TOOLS	SHANK SIZE H X B (mm)	L (mm)	RIGHT HAND (RH)		LEFT HAND (LH)		PRICE RS./ PIECE
			ORDER CODE - MIR100				
			P30	K20	P30	K20	
	5050	240	2134RC	2131RC	2134LC	2131LC	10,185
	1610	110	2024RC	2021RC	2024LC	2021LC	536
	2012	125	2044RC	2041RC	2044LC	2041LC	726
	2516	140	2064RC	2061RC	2064LC	2061LC	974
	3220	170	2084RC	2081RC	2084LC	2081LC	1,832
	4025	200	2104RC	2101RC	2104LC	2101LC	2,782
	5032	240	2124RC	2121RC	2132LC	2121LC	5,759
ISO 7 (150) PARTING OFF TOOLS	1010	90	5103RC	5201RC	5204LC	5201LC	541
	1212	100	5214RC	5211RC	5214LC	5211LC	615
	1616	110	5314RC	5231RC	5314LC	5231LC	683
	2020	125	5254RC	5180RC	5254LC	5180LC	754
	2525	140	5071RC	5061RC	5071LC	5061LC	1,010
	3232	170	5274RC	5271RC	5274LC	5271LC	1,604
	1006	90	5104RC	5101RC	5104LC	5101LC	452
	1208	100	5114RC	5111RC	5114LC	5111LC	536
	1610	110	5124RC	5121RC	5124LC	5121LC	569
	2012	125	5134RC	5131RC	5134LC	5131LC	631
	2516	140	5144RC	5141RC	5144LC	5141LC	836
	3220	170	5154RC	5151RC	5154LC	5151LC	1,342
	4025	200	5164RC	5161RC	5164LC	5161LC	2,218
5032	240	5166RC	5301RC	5304LC	5301LC	3,137	
ISO 8 (130) BORING TOOLS (SQUARE)	0808	125	2804RC	2801RC	2804LC	2801LC	833
	1010	150	2814RC	2811RC	2814LC	2811LC	893
	1212	180	2827RC	2823RC	2827LC	2823LC	974
	1616	210	2834RC	2831RC	2834LC	2831LC	1,170
	2020	250	2844RC	2841RC	2844LC	2841LC	1,432
	2525	300	2854RC	2851RC	2854LC	2851LC	2,676
	3232	355	2864RC	2861RC	2864LC	2861LC	3,479
	4040	400	2874RC	2871RC	2874LC	2871LC	5,052
5050	450	2878RC	2877RC	2878LC	2877LC	9,278	
ISO 8 (131) BORING TOOLS (ROUND)	Ø08	125	2904RC	2901RC	2904LC	2901LC	773
	Ø10	150	2914RC	2911RC	2914LC	2911LC	833
	Ø12	180	2924RC	2921RC	2924LC	2921LC	893
	Ø16	210	2934RC	2931RC	2934LC	2931LC	1,026
	Ø20	250	2944RC	2941RC	2944LC	2941LC	1,253
	Ø25	300	2954RC	2951RC	2954LC	2951LC	2,382
Ø32	355	2964RC	2961RC	2964LC	2961LC	3,033	

ISO 9 (135) BORING TOOLS (SQUARE)	SHANK SIZE H X B (mm)	L (mm)	RIGHT HAND (RH)		LEFT HAND (LH)		PRICE RS./ PIECE
			ORDER CODE - MIR100				
			P30	K20	P30	K20	
	0808	125	3004RC	3001RC	3004LC	3001LC	833
	1010	150	3014RC	3011RC	3014LC	3011LC	893
	1212	180	3024RC	3021RC	3024LC	3021LC	974
	1616	210	3034RC	3031RC	3034LC	3031LC	1,170
	2020	250	3044RC	3041RC	3044LC	3041LC	1,432
	2525	300	3054RC	3051RC	3054LC	3051LC	2,676
	3232	355	3064RC	3061RC	3064LC	3061LC	3,479
	4040	400	3068RC	3062RC	3068LC	3062LC	5,052
ISO 9 (136) BORING TOOLS (ROUND)	Ø08	125	3104RC	3101RC	3104LC	3101LC	773
	Ø10	150	3114RC	3111RC	3114LC	3111LC	833
	Ø12	180	3124RC	3121RC	3124LC	3121LC	893
	Ø16	210	3134RC	3131RC	3134LC	3131LC	1,026
	Ø20	250	3144RC	3141RC	3144LC	3141LC	1,253
	Ø25	300	3154RC	3151RC	3154LC	3151LC	2,382
	Ø32	355	3164RC	3161RC	3164LC	3161LC	3,033
113 - STRAIGHT ROUND NOSE TURNING TOOLS	NEUTRAL (NH)						
	1010	90	1404SC	1401SC			452
	1212	100	1414SC	1411SC			497
	1616	110	1434SC	1431SC			699
	2020	125	1454SC	1451SC			1,084
	2525	140	1474SC	1471SC			1,564
	3232	170	1494SC	1491SC			2,906
	4040	200	1614SC	1506SC			5,389
	1610	110	1424SC	1421SC			541
	2012	125	1444SC	1441SC			662
	2516	140	1464SC	1461SC			906
	3220	170	1484SC	1481SC			1,259
	4025	200	1504SC	1501SC			2,528
	5032	240	0057AC	0057SC			4,743
115 CRANKED ROUND NOSE TURNING TOOLS.			RIGHT HAND (RH)		LEFT HAND (LH)		
	1010	90	1604RC	1601RC	1604LC	1601LC	497
	1212	100	1614RC	1611RC	1614LC	1611LC	530
	1616	110	1634RC	1631RC	1634LC	1631LC	726
	2020	125	1654RC	1651RC	1654LC	1651LC	1,084
	2525	140	1674RC	1671RC	1674LC	1671LC	1,564
	3232	170	1694RC	1691RC	1694LC	1691LC	3,033
	4040	200	1714RC	1711RC	1714LC	1711LC	5,620
	1610	110	1624RC	1621RC	1624LC	1621LC	596
	2012	125	1644RC	1641RC	1644LC	1641LC	699
	2516	140	1664RC	1661RC	1664LC	1661LC	953
	3220	170	1684RC	1681RC	1684LC	1681LC	1,325
	4025	200	1704RC	1701RC	1704LC	1701LC	2,641

116 - BAR TURNING TOOLS	SHANK SIZE H X B (mm)	L (mm)	RIGHT HAND (RH)		LEFT HAND (LH)		PRICE RS./ PIECE
			ORDER CODE - MIR100				
			P30	K20	P30	K20	
	1010	90	1804RC	1801RC	1804LC	1801LC	409
	1212	100	1814RC	1811RC	1814LC	1811LC	452
	1616	110	1834RC	1831RC	1834LC	1831LC	604
	2020	125	1854RC	1851RC	1854LC	1851LC	893
	2525	140	1874RC	1871RC	1874LC	1871LC	1382
	3232	170	1894RC	1891RC	1894LC	1891LC	2388
	4040	200	1914RC	1911RC	1914LC	1911LC	4717
	5050	240	1934RC	1931RC	1934LC	1931LC	10031
	1610	110	1824RC	1821RC	1824LC	1821LC	485
	2012	125	1844RC	1841RC	1844LC	1841LC	785
	2516	140	1864RC	1861RC	1864LC	1861LC	1120
	3220	170	1884RC	1881RC	1884LC	1881LC	1537
	4025	200	1904RC	1901RC	1904LC	1901LC	2466
122 - POINTED TURNING TOOLS	NEUTRAL (NH)						
	1010	90	0805SC	0801SC			452
	1212	100	0815SC	0811SC			553
	1616	110	0835SC	0831SC			610
	2020	125	0855SC	0851SC			836
	2525	140	0875SC	0871SC			1189
	3232	170	0895SC	0891SC			2950
	4040	200	0902SC	0903SC			5414
	5050	240	0925SC	0926SC			5904
	1610	110	0825SC	0821SC			604
	2012	125	0845SC	0841SC			640
	2516	140	0865SC	0861SC			836
	3220	170	0885SC	0881SC			1244
	4025	200	0905SC	0901SC			2080
	5032	240	0906SC	0907SC			4364
140 (60°) BORING TOOLS (SQUARE)			RIGHT HAND (RH)		LEFT HAND (LH)		
	0808	24	3604RC	3601RC	3604LC	3601LC	521
	1010 & 3/8"	50	3614RC	3611RC	3614LC	3611LC	521
	1212 & 1/2"	60	3624RC	3621RC	3624LC	3621LC	597
	1616 & 5/8"	90	3634RC	3631RC	3634LC	3631LC	836
	2020 & 3/4"	120	3644RC	3641RC	3644LC	3641LC	1327
	2525 & 1"	175	3654RC	3651RC	3654LC	3651LC	1749
140 (60°) BORING TOOLS (ROUND)							
	Ø8	24	3504RC	3501RC	3504LC	3501LC	452
	Ø10 & 3/8"	50	3514RC	3511RC	3514LC	3511LC	452
	Ø12 & 1/2"	60	3524RC	3521RC	3524LC	3521LC	530
	Ø16 & 5/8"	90	3534RC	3531RC	3534LC	3531LC	688
	Ø20 & 3/4"	120	3544RC	3541RC	3544LC	3541LC	1232
	Ø25 & 1"	175	3554RC	3551RC	3554LC	3551LC	1598

141 (90°) BORING TOOLS (SQUARE) 	SHANK SIZE H X B (mm)	L (mm)	RIGHT HAND (RH)		LEFT HAND (LH)		PRICE RS./ PIECE
			ORDER CODE - MIR100				
			P30	K20	P30	K20	
	0808	24	4104RC	4101RC	4104LC	4101LC	521
	1010 & 3/8"	50	4114RC	4111RC	4114LC	4111LC	521
	1212 & 1/2"	60	4124RC	4121RC	4124LC	4121LC	597
	1616 & 5/8"	90	4134RC	4131RC	4134LC	4131LC	836
	2020 & 3/4"	120	4144RC	4141RC	4144LC	4141LC	1327
	2525 & 1"	175	4154RC	4151RC	4154LC	4151LC	1749
141 (90°) BORING TOOLS (ROUND) 	Ø08	24	4004RC	4001RC	4004LC	4001LC	452
	Ø10 & 3/8"	50	4014RC	4011RC	4014LC	4011LC	452
	Ø12 & 1/2"	60	4024RC	4021RC	4024LC	4021LC	530
	Ø16 & 5/8"	90	4034RC	4031RC	4034LC	4031LC	688
	Ø20 & 3/4"	120	4044RC	4041RC	4044LC	4041LC	1232
	Ø25 & 1"	175	4054RC	4051RC	4054LC	4051LC	1598
142 (45°) BORING TOOLS (SQUARE) 	0808	24	4604RC	4601RC	4604LC	4601LC	521
	1010 & 3/8"	50	4614RC	4611RC	4614LC	4611LC	521
	1212 & 1/2"	60	4624RC	4621RC	4624LC	4621LC	597
	1616 & 5/8"	90	4634RC	4631RC	4634LC	4631LC	836
	2020 & 3/4"	120	4644RC	4641RC	4644LC	4641LC	1327
	2525 & 1"	175	4654RC	4651RC	4654LC	4651LC	1749
142 (45°) BORING TOOLS (ROUND) 	Ø08	24	4504RC	4501RC	4504LC	4501LC	452
	Ø10 & 3/8"	50	4514RC	4511RC	4514LC	4511LC	452
	Ø12 & 1/2"	60	4524RC	4521RC	4524LC	4521LC	530
	Ø16 & 5/8"	90	4534RC	4531RC	4534LC	4531LC	688
	Ø20 & 3/4"	120	4544RC	4541RC	4544LC	4541LC	1232
	Ø25 & 1"	175	4554RC	4551RC	4554LC	4551LC	1598
156 - CRANKED INTERNAL RECESSING TOOLS 	1010	90	5404RC	5401RC	5404LC	5401LC	855
	1212	100	5414RC	5411RC	5414LC	5411LC	974
	1616	110	5424RC	5421RC	5424LC	5421LC	1091
	2020	125	5434RC	5431RC	5434LC	5431LC	1410
	2525	140	5444RC	5441RC	5444LC	5441LC	1931
	3232	170	5454RC	5451RC	5454LC	5451LC	2747
	4040	315	5464RC	5461RC	5464LC	5461LC	4557
163 - STRAIGHT TURNING & GROOVING TOOLS 	NEUTRAL (NH)						
	1010	90	5704SC	5701SC			553
	1212	100	5714SC	5711SC			631
	1616	110	5734SC	5731SC			953
	2020	125	5754SC	5751SC			1389
	2525	140	5774SC	5771SC			2320
	3232	170	5794SC	5791SC			5053
	4040	200	5798SC	5762SC			9701
	1610	110	5724SC	5721SC			541
	2012	125	5744SC	5741SC			690
	2516	140	5764SC	5761SC			1045
	3220	170	5784SC	5781SC			1712

165 - STRAIGHT THREADING TOOLS (60°)	SHANK SIZE H X B (mm)	L (mm)	RIGHT HAND (RH)		LEFT HAND (LH)		PRICE RS./ PIECE
			ORDER CODE - MIR100				
			P30	K20	P30	K20	
	1010	90	6002RC	6001RC	6002LC	6001LC	597
	1212	100	6012RC	6011RC	6012LC	6011LC	632
	1616	110	6044RC	6031RC	6044LC	6031LC	823
	2020	125	6054RC	6051RC	6054LC	6051LC	1,120
	2525	140	6074RC	6071RC	6074LC	6071LC	1,665
	3232	170	6094RC	6091RC	6094LC	6091LC	2,204
166 - INTERNAL THREADING TOOLS (60°)	1010	90	6204RC	6201RC	6204LC	6201LC	987
	1212	100	6214RC	6211RC	6214LC	6211LC	1,116
	1616	110	6224RC	6221RC	6224LC	6221LC	1,211
	2020	125	6234RC	6231RC	6234LC	6231LC	1,485
	2525	140	6256RC	6241RC	6256LC	6241LC	1,944
	3232	170	6254RC	6251RC	6254LC	6251LC	2,933
IND-2-EXTERNAL THREADING TOOLS	1010	90	0905RC	0901RC	0905LC	0901LC	701
	1212	100	0915RC	0911RC	0915LC	0911LC	828
	1616	110	0935RC	0931RC	0935LC	0931LC	880
	2020	125	0955RC	9101RC	0955LC	9101LC	977
	2525	140	0975RC	0971RC	0975LC	0971LC	1,633
THREADING TOOLS WITH "V" PROFILE	NEUTRAL (NH)						
	166 - 11	140	6264RC	6261RC			902
	166 - 12	160	6274RC	6271RC			1,101
	166 - 13	180	6284RC	0114RC			1,537
	166 - 14	200	6294RC	6292RC			2,144

Indian Standard Application of Carbides for Machining, Ranges of application and Colour Code Selection Guideline for Tip Grade

Identification Colour	Designation	Material to be Machined
	P20	Steel, steel casting, Malleable cast iron forming long chips Machining Conditions Turning & Milling-Medium cutting speed and medium chip section, Planing with small chip section
	P30	Steel, steel casting, Malleable cast iron forming long chips Machining Conditions Turning, Milling & Planning-Medium or low cutting speed, medium or large chip section and machining under unfavourable conditions such as heat erogenous materials, changing hardness or chip section, intermittent turning or subject to vibrations.
	P40	Steel, steel casting with sand inclusions or shrinkage cavities Machining Conditions Turning, Planning & Shapping-Low cutting speed, large chip section with possibility of using large rake angle for machining under unfavourable conditions, such as heat erogenous materials, changing hardness or chip sections, intermillent turning or subject to vibrations; and work on automatic machines.
	K10	Grey cast iron of hardness more than 220 HB, Malleable cast iron forming short chips, Tempered steel, Aluminium alloys containing silicon, copper alloys, plastics, glass, hard rubber, hard carboard, porcelain, stone. Machining Conditions Turning, Milling, Boring, Scraping
	K20	Grey cast iron of hardness up to 220 HB, Non-ferrous metals, such as Copper, Brass, . Aluminium, Laminated wood of abrasive type Machining Conditions Turning, Milling, planning, requiring high toughness.

TUNGSTEN CARBIDE ROTARY BURRS



PRODUCT RANGE

Types : Cylindrical & with Radius Flame, Rim & Inverted Cone
Tree shape - Radius / Pointed end
Cone shape - Radius / Pointed end

Range : Diameter 3.0 mm to 25.0 mm, Shank 3.0 mm, 6.0 mm & 8.0 mm
Single cut, Double cut, Diamond cut & Aluma cut

APPLICATIONS

- Cast Iron
- Mild Steel
- Stainless Steel
- Forged Steel
- Titanium
- Aluminium

INDUSTRIES

- Foundry, Casting & Fabrication
- Marine & Shipbuilding
- Automobile, Heavy Engineering
- Tubes & Pipes
- Aerospace & Defense
- Gear Manufacturing

TUNGSTEN CARBIDE ROTARY BURRS

SHAPE	MIRANDA CODE	DESCRIPTION	PRICE RS./ PIECE			
			ORDER CODE	STANDARD PRICE	ORDER CODE	TIN COATED PRICE
		HEAD DIA X HEAD LENGTH	MIRTCRBFU		MIRTCRBFU	
X OAL LENGTH X SHANK DIA						
 CONICAL	MAM1	3MM X 11MM X 38MM X 3SHK	1011AS	558	1011AS	615
	MAM2	6MM X 11MM X 38MM X 3SHK	1012BS	731	1012BS	806
	AM1	6MM X 19MM X 60MM X 6SHK	1010AS	867	1010AS	953
	AM2	10MM X 20MM X 70MM X 6SHK	1020BS	867	1020BS	953
	AM3	12MM X 25MM X 75MM X 6SHK	1030CS	1191	1030CS	1309
	AM4	10MM X 12MM X 60MM X 6SHK	1040DS	903	1040DS	991
	AM5	16MM X 13MM X 63MM X 6SHK	1050ES	1300	1050ES	1464
	AM6	16MM X 16MM X 66MM X 6SHK	1060FS	1300	1060FS	1464
 CYLINDRICAL RADIUS END	MBM1	3MM X 16MM X 38MM X 3SHK	2011AS	558	2011AS	615
	MBM2	6MM X 13MM X 38MM X 3SHK	2012BS	731	2012BS	806
	BM1	6MM X 20MM X 50MM X 6SHK	2010AS	877	2010AS	962
	BM2	8MM X 20MM X 70MM X 6SHK	2020BS	847	2020BS	933
	BM3	10MM X 20MM X 70MM X 6SHK	2030CS	1058	2030CS	1164
	BM4	12MM X 20MM X 70MM X 6SHK	2040DS	1365	2040DS	1530
	BM5	16MM X 25MM X 75MM X 6SHK	2050ES	2088	2050ES	2337
	BM6	12MM X 25MM X 75MM X 6SHK	2060FS	1895	2060FS	2126
 CYLINDRICAL	MCM1	3MM X 16MM X 38MM X 3SHK	3011AS	558	3011AS	615
	MCM2	6MM X 6MM X 38MM X 3SHK	3012BS	627	3012BS	692
	MCM3	6MM X 13MM X 38MM X 3SHK	3013CS	731	3013CS	806
	CM1	4MM X 15MM X 50MM X 6SHK	3010AS	731	3010AS	806
	CM2	6MM X 20MM X 60MM X 6SHK	3020BS	839	3020BS	924
	CM3	8MM X 20MM X 70MM X 6SHK	3030CS	953	3030CS	1048
	CM4	10MM X 20MM X 70MM X 6SHK	3040DS	1048	3040DS	1154
	CM5	12MM X 20MM X 70MM X 6SHK	3050ES	1318	3050ES	1473
	CM6	16MM X 25MM X 75MM X 6SHK	3060FS	2113	3060FS	2364
	CM7	12MM X 16MM X 65MM X 6SHK	3070GS	1287	3070GS	1441
	CM8	12MM X 25MM X 75MM X 6SHK	3080HS	2088	3080HS	2337
 FLAME	FM1	6MM X 15MM X 50MM X 6SHK	4010AS	839	4010AS	924
	FM2	8MM X 20MM X 70MM X 6SHK	4020BS	867	4020BS	953
	FM3	10MM X 25MM X 65MM X 6SHK	4030CS	1711	4030CS	1914
	FM4	12MM X 32MM X 82MM X 6SHK	4040DS	2055	4040DS	2320
 CONE RADIUS	MKM1	3MM X 8MM X 38MM X 3SHK	5011AS	558	5011AS	615
	MKM2	6MM X 12MM X 38MM X 3SHK	5012BS	731	5012BS	806
	KM1	10MM X 20MM X 65MM X 6SHK	5010AS	820	5010AS	903
	KM2	12MM X 20MM X 70MM X 6SHK	5020BS	1365	5020BS	1530
	KM3	16MM X 33MM X 75MM X 6SHK	5030CS	1885	5030CS	2106

SHAPE	MIRANDA CODE	DESCRIPTION	PRICE RS./ PIECE			
			ORDER CODE	STANDARD PRICE	ORDER CODE	TIN COATED PRICE
		HEAD DIA X HEAD LENGTH				
		X OAL LENGTH X SHANK DIA	MIRTCRBFU		MIRTCRBFU	
 OVAL	MOM1	3MM X 8MM X 38MM X 3SHK	MOM1S0814	558	MOM1S0814	615
	MOM2	6MM X 10MM X 38MM X 3SHK	MOM2S0610	731	MOM2S0610	806
	OM1	8MM X 14MM X 60MM X 6SHK	OM10S0814	933	OM10S0814	1030
	OM2	12MM X 20MM X 70MM X 6SHK	OM20S1220	1365	OM20S1220	1530
	OM3	16MM X 25MM X 75MM X 6SHK	OM30S1625	2106	OM30S1625	2356
	OM4	6MM X 10MM X 60MM X 6SHK	OM40S0610	933	OM40S0610	1030
 RIM	RM1	10MM X 2MM X 50MM X 6SHK	RM10S1002	820	RM10S1002	903
	RM2	20MM X 6MM X 60MM X 6SHK	RM20S2006	1538	RM20S2006	1693
	RM3	12MM X 10MM X 60MM X 6SHK	RM30S1210	1365	RM30S1210	1502
 BALL	MSM1	4MM X 3MM X 38MM X 3SHK	MSM1S0403	647	MSM1S0403	711
	MSM2	5MM X 4MM X 38MM X 3SHK	MSM2S0504	675	MSM2S0504	743
	SM1	6MM X 5MM X 50MM X 6SHK	SM10S0605	806	SM10S0605	885
	SM2	8MM X 7MM X 50MM X 6SHK	SM20S0807	848	SM20S0807	933
	SM3	10MM X 9MM X 60MM X 6SHK	SM30S1009	848	SM30S1009	933
	SM4	12MM X 11MM X 60MM X 6SHK	SM40S1211	1065	SM40S1211	1170
	SM5	16MM X 14MM X 65MM X 6SHK	SM50S1614	1441	SM50S1614	1617
 TREE POINTED END	MTM1	3MM X 13MM X 38MM X 3SHK	MTM1S0313	558	MTM1S0313	615
	MTM2	3MM X 16MM X 38MM X 3SHK	MTM2S0316	558	MTM2S0316	615
	MTM3	6MM X 13MM X 38MM X 3SHK	MTM3S0613	731	MTM3S0613	806
	TM1	6MM X 20MM X 70MM X 6SHK	TM10S0620	885	TM10S0620	971
	TM2	10MM X 20MM X 70MM X 6SHK	TM20S1020	1058	TM20S1020	1164
	TM3	12MM X 25MM X 75MM X 6SHK	TM30S1225	1268	TM30S1225	1397
	TM4	16MM X 30MM X 80MM X 6SHK	TM40S1630	1885	TM40S1630	2106
 TREE RADIUS END	TBM1	6MM X 20MM X 70MM X 6SHK	TBM1S0620	885	TBM1S0620	971
	TBM2	10MM X 20MM X 70MM X 6SHK	TBM2S1020	1058	TBM2S1020	1164
	TBM3	12MM X 25MM X 75MM X 6SHK	TBM3S1225	1337	TBM3S1225	1502
 INVERTED CONE	MIM1	3MM X 8MM X 38MM X 3SHK	MIM1S0308	558	MIM1S0308	615
	MIM2	6MM X 8MM X 38MM X 3SHK	MIM2S0608	627	MIM2S0608	692

SOLID CARBIDE TOOLS

MIRANDA
Maxx



**SOLID CARBIDE TOOLS
END MILLS**



SC4M 4 FLUTE - TiAIN coated				
Dia	SH.DIA	FL	OAL	PRICE RS./PIECE
1.0	3.0	3	38	1,175
1.5	3.0	6	38	1,175
2.0	3.0	9	38	1,175
2.5	3.0	9	38	1,175
3.0	3.0	12	38	1,107
3.5	4.0	14	50	1,454
4.0	4.0	14	50	1,454
4.5	5.0	16	50	1,826
5.0	5.0	20	50	1,826
5.5	6.0	20	60	1,906
6.0	6.0	20	60	1,906
8.0	8.0	20	60	2,110
10.0	10.0	25	75	4,014
12.0	12.0	25	75	4,656
14.0	14.0	25	75	8,176
16.0	16.0	32	89	8,836
20.0	20.0	38	100	18,777

SCBALL NOSE-EM 4 FLUTE - TiAIN coated				
Dia	SH.DIA	FL	OAL	PRICE RS./PIECE
1.0	3.0	3	38	1,484
1.5	3.0	5	38	1,484
2.0	3.0	7	38	1,484
2.5	3.0	7	38	1,484
3.0	3.0	9	38	1,337
4.0	4.0	14	50	1,744
5.0	5.0	16	50	2,196
6.0	6.0	20	60	2,290
8.0	8.0	20	60	2,582
10.0	10.0	25	75	4,812
12.0	12.0	25	75	5,594
16.0	16.0	32	89	10,622
20.0	20.0	38	102	22,534



LONG LENGTH 4 FLUTE				PRICE RS./PIECE
Dia	SH.DIA	FL	OAL	
3	3	20	60	2,112
4	4	20	60	2,383
5	5	25	75	2,656
6	6	30	75	2,771
8	8	40	100	3,084
10	10	40	100	4,863
10	10	75	150	11,103
12	12	50	100	6,971
12	12	75	150	13,619
16	16	75	150	20,432
20	20	75	150	33,984

SCNB - LONG LENGTH 4 FLUTE				PRICE RS./PIECE
Dia	SH.DIA	FL	OAL	
3	3	20	60	2,532
4	4	20	60	2,863
5	5	25	75	3,184
6	6	30	75	3,329
8	8	40	100	3,662
10	10	40	100	5,837
10	10	75	150	13,326
12	12	50	100	8,354
12	12	75	150	16,345
16	16	75	150	24,521
20	20	75	150	40,783



**SOLID CARBIDE TOOLS
DRILL**



Solid Carbide Jobber Drill -TiAlN Coated				
Dia	SH.DIA	FL	OAL	PRICE RS./ PIECE
1.0	1.0	12	32	1,011
1.5	1.5	18	40	1,085
2.0	2.0	24	49	1,241
2.5	2.5	30	57	1,241
3.0	3.0	33	61	1,389
3.5	3.5	39	70	1,512
4.0	4.0	43	75	1,860
4.5	4.5	47	80	1,992
5.0	5.0	52	86	2,281
5.5	5.5	57	93	2,641
6.0	6.0	57	93	2,747
6.5	6.5	63	101	3,093
7.0	7.0	69	109	3,387
7.5	7.5	69	109	3,697
8.0	8.0	75	117	4,169
8.5	8.5	75	117	4,567
9.0	9.0	81	125	5,182
9.5	9.5	81	125	5,916
10.0	10.0	87	133	6,791
10.5	10.5	87	133	7,589
11.0	11.0	94	142	9,032
12.0	12.0	101	151	10,325
13.0	13.0	101	151	12,902
14.0	14.0	108	160	16,108
16.0	16.0	120	178	23,915

Solid Carbide Stub Drill-TiAlN Coated				
Dia	SH.DIA	FL	OAL	PRICE RS./ PIECE
1.0	1.0	6	26	928
1.5	1.5	9	32	997
2.0	2.0	12	38	1,140
2.5	2.5	14	43	1,140
3.0	3.0	16	46	1,276
3.5	3.5	20	52	1,316
4.0	4.0	22	55	1,620
4.5	4.5	24	58	1,733
5.0	5.0	26	62	1,986
5.5	5.5	28	66	2,298
6.0	6.0	28	66	2,391
6.5	6.5	31	70	2,568
7.0	7.0	34	74	2,811
7.5	7.5	34	74	3,069
8.0	8.0	37	79	3,460
8.5	8.5	37	79	3,791
9.0	9.0	40	84	4,060
9.5	9.5	40	84	4,637
10.0	10.0	43	89	5,320
10.5	10.5	43	89	5,946
11.0	11.0	47	95	7,809
12.0	12.0	51	102	7,809
13.0	13.0	51	103	11,683
14.0	14.0	54	107	11,683
16.0	16.0	58	115	17,354

- END MILL FOR 60HRC ON REQUEST
- END MILL WITH CORNER RADIUS & SPECIAL ON REQUEST.
- PRICES ARE SUBJECT TO REVISION WITHOUT ANY NOTICE.

SUGGESTED SPEED AND FEED DATA FOR SOLID CARBIDE ENDMILLS

Application : Slotting / Key way machining

Material HRc Diameter	Carbon steel , Alloy Steel < HRc 28		Carbon steel , Alloy Steel HRc 28 - HRc 45		Stainless Steel and Super alloys		Cast Iron	
	RPM	feed/tooth	RPM	feed/tooth	RPM	feed/tooth	RPM	feed/tooth
2	6369	0.03	6369	0.024	6369	0.02	6369	0.044
3	4777	0.045	4777	0.036	4777	0.03	4777	0.066
4	3981	0.06	3981	0.048	3981	0.04	3981	0.088
5	3185	0.075	3185	0.06	3185	0.05	3185	0.11
6	2654	0.09	2654	0.072	2654	0.06	2654	0.132
8	1990	0.12	1990	0.096	1990	0.08	1990	0.176
10	1911	0.15	1911	0.12	1911	0.1	1911	0.22
12	1592	0.18	1592	0.144	1592	0.12	1592	0.264
14	1365	0.21	1365	0.168	1365	0.14	1365	0.308
16	1393	0.24	1393	0.192	1393	0.16	1393	0.352
18	1238	0.27	1238	0.216	1238	0.18	1238	0.396
20	1115	0.3	1115	0.24	1115	0.2	1115	0.44

- Reduce feed rate by around 30% in case of long types
- Increase speed and feed rate by around 25% in case of coated endmills

Application : End milling

Material HRc Diameter	Carbon steel , Alloy Steel < HRc 28		Carbon steel , Alloy Steel HRc 28 - HRc 45		Stainless Steel and Super alloys		Grey Cast Iron	
	RPM	feed/tooth	RPM	feed/tooth	RPM	feed/tooth	RPM	feed/tooth
2	6369	0.04	6369	0.03	6369	0.024	6369	0.06
3	4777	0.06	4777	0.045	4777	0.036	4777	0.09
4	3981	0.08	3981	0.06	3981	0.048	3981	0.12
5	3185	0.1	3185	0.075	3185	0.06	3185	0.15
6	2654	0.12	2654	0.09	2654	0.072	2654	0.18
8	1990	0.16	1990	0.12	1990	0.096	1990	0.24
10	1911	0.2	1911	0.15	1911	0.12	1911	0.3
12	1592	0.24	1592	0.18	1592	0.144	1592	0.36
14	1365	0.28	1365	0.21	1365	0.168	1365	0.42
16	1393	0.32	1393	0.24	1393	0.192	1393	0.48
18	1238	0.36	1238	0.27	1238	0.216	1238	0.54
20	1115	0.4	1115	0.3	1115	0.24	1115	0.6

SUGGESTED SPEED AND FEED DATA FOR SOLID CARBIDE DRILLS

Application : Drilling

Material HRc Diameter	Carbon steel , Alloy Steel < HRc 28		Carbon steel , Alloy Steel HRc 28 - HRc 45		Stainless Steel and Super alloys		Cast Iron	
	RPM	mm/rev	RPM	mm/rev	RPM	mm/rev	RPM	mm/rev
2	5100	0.04	5100	0.03	4900	0.02	5100	0.06
3	4246	0.045	4246	0.036	4246	0.03	4246	0.066
4	3583	0.06	3583	0.048	3583	0.04	3583	0.088
5	2866	0.075	2866	0.06	2866	0.05	2866	0.11
6	2389	0.09	2389	0.072	2389	0.06	2389	0.132
8	1990	0.12	1990	0.096	1990	0.08	1990	0.176
10	1592	0.15	1592	0.12	1592	0.10	1592	0.22
12	1327	0.18	1327	0.144	1327	0.12	1327	0.264
14	1251	0.21	1251	0.168	1251	0.14	1251	0.308
16	1194	0.24	1194	0.192	1194	0.16	1194	0.352
18	1062	0.27	1062	0.216	1062	0.18	1062	0.396
20	1115	0.3	1115	0.24	1115	0.2	1115	0.44

- Increase speed and feed rate by around 25% in case of coated endmills
- Reduce feed rate by around 30% in case of long types
- Increase speed and feed rate by around 25% in case of coated Drills

Technical Formulae

Cutting speed. = $\pi \times \text{Dia of Tool} \times \text{RPM} / 1000$

Feed in mm per revolution. = feed in mm per tooth X no. of flutes

Feed in mm per min. = RPM X feed in mm per revolution.

Cutting time. = Cutting length / feed in mm per min

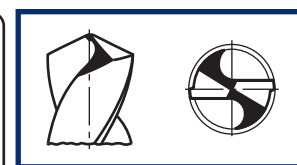

Split Point Geometry